



Daikin Altherma mid  
temperature split  
Technical Data  
ERRA08-12EV3





# TABLE OF CONTENTS

# ERRA08-12EV3

1	<b>Features</b>	4
	ERRA08-12EV3	4
2	<b>Specifications</b>	5
3	<b>Capacity graphs</b>	77
	Cooling Capacity Graphs	77
	Cooling Capacity Graphs - quiet mode	78
	Heating Capacity Graphs	79
	Heating Capacity Graphs - quiet mode	80
4	<b>Capacity tables</b>	81
	Certification Programs	81
	Domestic Hot Water performance	82
5	<b>Dimensional drawings</b>	83
6	<b>Piping diagrams</b>	84
7	<b>Wiring diagrams</b>	85
	Wiring Diagrams - Single Phase	85
8	<b>Sound data</b>	86
	Sound Pressure Spectrum - Cooling	86
	Sound Pressure Spectrum - Heating	87
	Sound Pressure Spectrum Quiet Mode	88
9	<b>Installation</b>	89
	Installation Method	89
10	<b>Operation range</b>	90

# 1 Features

## 1 - 1 ERRA08-12EV3

- › Outdoor unit extracts heat from the outdoor air, even at -25°C
- › By heat pump operation only, the outdoor unit delivers a leaving water temperature of 65°C at -15°C ambient temperature
- › By -15°C ambient temperature, the outdoor unit limits heating capacity loss
- › Choosing for an R-32 product, reduces the environmental impact with 68% compared to R-410A, leads directly to lower energy consumption thanks to its high energy efficiency and has a 30% lower refrigerant charge
- › WLAN cartridge included



Guaranteed operation down to -25°C



Onecta app

## 2 Specifications

### 2 - 1 Specifications

Technical specifications					ELBH12E6V + ERRA08EV3	ELBH12E6V + ERRA10EV3	ELBH12E6V + ERRA12EV3	
Heating capacity	Min.			kW	3.45 (1)			
	Nom.			kW	6.17 (2)			
	Max.			kW	7.95 (1)	9.25 (1)	9.97 (1)	
Power input	Heating	Min.		kW	0.72 (3)			
		Nom.		kW	1.25 (2)			
		Max.		kW	1.69 (3)	2.04 (3)	2.28 (3)	
COP					4.92 (2)			
Pump	Type				Grundfos UPM4L K 15-75 130 9 DK1			
	Nominal ESP	Heating		kPa	67.9 (4)			
Water side Heat exchanger	Water flow rate	Heating	Nom.	l/min	18.3			
General	Supplier/	Name and address			Daikin Europe N.V. - Zandvoordestraat 300, 8400 Oostende, Belgium			
	Manufacturer details	Name or trademark			Daikin Europe N.V.			
	Product description	Air-to-water heat pump			Yes			
		Brine-to-water heat pump			No			
		Heat pump combination heater			Yes			
		Low-temperature heat pump			No			
		Supplementary heater integrated			Yes			
	LW(A) Sound power level (according to EN14825)	Indoor			dB(A)	44.0		
Outdoor				dB(A)	56.0			
Sound condition Ecodesign and energy label					Sound power in heating mode, measured according to the EN12102 under conditions of the EN14825			
Space heating general	Air to water unit	Rated airflow (outdoor)			m <sup>3</sup> /h	3,542		
		Other	Capacity control				Inverter	
	Pck (Crankcase heater mode)			kW	0.000			
	Poff (Off mode)			kW	0.021			
	Psb (Standby mode)			kW	0.021			
	Pto (Thermostat off)			kW	0.024			
	Integrated supplementary heater	Psup			kW	6.0		
Type of energy input				Electrical				
Space heating 	Average climate water outlet 55°C	General	Annual energy consumption		kWh	7,742	7,723	7,510
			ηs (Seasonal space heating efficiency)		%	130	131	135
		Prated at -10°C		kW	12.5			
		Qhe Annual energy consumption (GCV)		Gj	28		27	
		SCOP			3.34		3.44	
		Seasonal space heating eff. class			A++			
		A Condition (-7°CDB/-8°CWB)		Cdh (Degradation heating)			1.0	

## 2 Specifications

### 2 - 1 Specifications

Technical specifications				ELBH12E6V + ERRA08EV3	ELBH12E6V + ERRA10EV3	ELBH12E6V + ERRA12EV3	
Space heating	Average climate	A Condition (-7°CDB)	COPd		2.26		
			Pdh kW		7.6		
	water outlet 55°C	B/-8°CWB)	PERd %		90.4		
			Cdh (Degradation heating)		1.0		
		(2°CDB)	COPd		3.39		
		B/1°CWB)	Pdh kW		6.8		
			PERd %		135.6		
		C Condition (7°CDB)	Cdh (Degradation heating)		1.0		
			COPd		4.90		
		B/6°CWB)	Pdh kW		4.5		
			PERd %		196.0		
		D Condition (12°CDB)	Cdh (Degradation heating)		1.0		
			COPd		6.02		
		B/11°CWB)	Pdh kW		5.2		
			PERd %		240.8		
	Tol (temperature operating limit)		COPd	1.97		2.00	
			Pdh kW	6.9		8.2	
			PERd %	78.8		80.0	
			TOL °C			-10	
			WTOL °C			55	
Rated heat output supplementary capacity		Psup (at Tdesign -10°C) kW	5.6		4.3		
	Tbiv (bivalent temperature)		COPd	2.81		2.41	
		Pdh kW	8.5		10.0		
		PERd %	112.4		96.4		
		Tbiv °C	-2		-5		
Cold climate water outlet 55°C	General	Annual energy consumption	kWh	7,303	7,173	7,146	
		ηs (Seasonal space heating efficiency)	%	118		121	
		Prated at -22°C	kW		9.0		
		Qhe Annual energy consumption (GCV)	Gj		26		
	A Condition (-7°CDB)		Cdh (Degradation heating)		1.0		
			COPd		2.52		
	B/-8°CWB)		Pdh kW		5.2		
			PERd %		100.6		
	B Condition (2°CDB)		Cdh (Degradation heating)		1.0		
			COPd		3.77		
B/1°CWB)		Pdh kW		3.3			
		PERd %		151.0			

## 2 Specifications

### 2 - 1 Specifications

Technical specifications				ELBH12E6V + ERRA08EV3	ELBH12E6V + ERRA10EV3	ELBH12E6V + ERRA12EV3	
Space heating Cold climate water outlet 55°C	C Condition (7°CDB- B/6°CWB)	Cdh (Degradation heating)		1.0			
		COPd		4.81			
		Pdh kW		3.4			
		PERd %		192.2			
		D Condition (12°CDB- B/11°CWB)		COPd		6.36	
			Pdh kW		4.2		
			PERd %		254.2		
	Tol (tem- perature operating limit)		COPd		1.43	1.49	1.54
			Pdh kW		4.9	6.1	7.2
			PERd %		57.4	59.7	61.7
			TOL °C		-22		
			WTOL °C		55		
	G Condition (-15°CDB/-)		COPd		1.93		1.96
			Pdh kW		6.0		7.2
			PERd %		77.2		78.4
	Tbiv (bivalent tempera- ture)		COPd		2.17		1.96
			Pdh kW		6.6		7.2
			PERd %		86.9		78.4
			Tbiv °C		-12		-15
	Rated heat output sup- plementary capacity		Psup (at Tdesign -22°C) kW		4.1	2.9	1.8
	Warm climate water outlet 55°C	General	Annual energy consumption		3,039		
			ηs (Seasonal space heating efficiency)		166		
			Prated at 2°C		9.6		
			Qhe Annual energy consumption (GCV)		11		
			B Condition (2°CDB- B/1°CWB)		Cdh (Degradation heating)		1.0
		COPd		2.57			
		Pdh kW		8.0			
		PERd %		102.6			
C Condition (7°CDB- B/6°CWB)		Cdh (Degradation heating)		1.0			
		COPd		3.65			
		Pdh kW		6.7			
		PERd %		146.2			
D Condition (12°CDB- B/11°CWB)		Cdh (Degradation heating)		1.0			
		COPd		5.71			
		Pdh kW		3.6			
		PERd %		228.3			
Tbiv (bivalent tempera- ture)		COPd		3.02			

## 2 Specifications

### 2 - 1 Specifications

Technical specifications				ELBH12E6V + ERRA08EV3	ELBH12E6V + ERRA10EV3	ELBH12E6V + ERRA12EV3	
Space heating	Warm climate water outlet 55°C	Tbiv	Pdh	kW			8.4
		(bivalent temperature)	PERd	%			120.9
			Tbiv	°C			4
	Average climate water outlet 35°C	General	Annual energy consumption		3,659		3,637
			ηs (Seasonal space heating efficiency)	%	184		186
			Prated at -10°C	kW			8.3
			Qhe Annual energy consumption (GCV)	Gj			13
			SCOP		4.69		4.71
			Seasonal space heating eff. class				A+++
			A Condition (-7°CDB/ -8°CWB)	COPd			3.10
	B Condition (2°CDB/ 1°CWB)	Pdh	kW		7.5		
		PERd	%		124.1		
		Cdh (Degradation heating)			1.0		
	C Condition (7°CDB/ 6°CWB)	COPd			4.76		
		Pdh	kW		4.4		
		PERd	%		190.4		
	D Condition (12°CDB/ 11°CWB)	Cdh (Degradation heating)			1.0		
		COPd			6.14		
		Pdh	kW		4.3		
	Tol (temperature operating limit)	PERd	%		245.8		
		Cdh (Degradation heating)			1.0		
		COPd			7.84		
	Tbiv (bivalent temperature)	Pdh	kW		6.6		
		PERd	%		313.4		
		TOL	°C		-10		
	Rated heat output supplementary capacity	WTOL	°C		35		
		COPd		2.80		2.77	
Pdh		kW	6.9		8.1		
Cold climate water outlet 35°C	PERd	%	112.2		110.8		
	TOL	°C			-10		
	WTOL	°C			35		
General	Tbiv	COPd		3.10		2.77	
	(bivalent temperature)	Pdh	kW	7.5		8.1	
		PERd	%	124.1		110.8	
General	Tbiv	°C		-7		-10	
	Rated heat output supplementary capacity	Psup (at Tdesign -10°C)	kW	1.4		0.0	
	Cold climate water outlet 35°C	General	Annual energy consumption	kWh	5,554	5,401	5,387
ηs (Seasonal space heating efficiency)			%	157	161	162	
Prated at -22°C			kW		9		

## 2 Specifications

### 2 - 1 Specifications

Technical specifications				ELBH12E6V + ERRA08EV3	ELBH12E6V + ERRA10EV3	ELBH12E6V + ERRA12EV3		
Space heating 	Cold climate water outlet 35°C	General Qhe Annual energy consumption (GCV)	Gj	20.0	19.4			
			A Condition (-7°CDB- B/-8°CWB)	COPd		3.36		
				Pdh	kW		5.4	
		PERd		%		134.5		
		B Condition (2°CDB- B/1°CWB)	Cdh (Degradation heating)			1.0		
			COPd			5.21		
			Pdh	kW		3.6		
		C Condition (7°CDB- B/6°CWB)	Cdh (Degradation heating)			1.0		
			COPd			6.29		
			Pdh	kW		5.3		
		D Condition (12°CDB- B/11°CWB)	Cdh (Degradation heating)			1.0		
			COPd			7.69		
			Pdh	kW		6.6		
		Tol (tem- perature operating limit)	COPd		2.04	2.07	2.09	
			Pdh	kW	4.9	5.9	6.4	
			PERd	%	81.6	82.9	83.6	
		TOL WTOL	°C			-22		
			°C			35		
			G Condition (-15°CDB/-)	COPd		2.60		2.56
		Pdh		kW	6.0		7.0	
		PERd		%	103.8		102.6	
		Tbiv (bivalent tempera- ture)	COPd		2.86		2.56	
			Pdh	kW	6.5		7.0	
			PERd	%	114.4		102.6	
Tbiv (°C)	°C		-12		-15			
	Rated heat output sup- plementary capacity		4.1	3.1	2.6			
	Warm climate water outlet 35°C	General Annual energy consumption ηs (Seasonal space heating efficiency)	kWh	2,027				
%			224					
Prated at 2°C			8.6					
B Condition (2°CDB- B/1°CWB)	Qhe Annual energy consumption (GCV)			7				
	Cdh (Degradation heating)			1.0				
	COPd			4.06				
C Condition (7°CDB- B/6°CWB)	Pdh		kW	6.8				
	PERd		%	162.4				
	Cdh (Degradation heating)			1.0				
D Condition (12°CDB- B/11°CWB)	COPd			5.65				
	Pdh		kW	5.5				
	PERd		%	226.0				
Tbiv (bivalent tempera- ture)	COPd			4.73				
	Pdh		kW	6.8				
	PERd		%	189.2				
Tbiv (°C)	°C			5				
	Cdh (Degradation heating)			1.0				
	COPd			7.52				
D Condition (12°CDB- B/11°CWB)	Pdh		kW	6.1				
	PERd		%	300.8				

(1)Capacity according to standard EN14511 and valid for heated water range dT = 3~8°C at Ta 7°C |

(2)Condition: Ta DB/WB 7°C/6°C - LWC 35°C (DT = 5°C) |

(3)Power input is total input of indoor and outdoor units, including the circulation pump; according to EN14511 |

(4)DB/WB 7°C/6°C - LWC 35°C (dT=5°C) with pump at full speed |

Cooling: EW 12°C; LW 7°C; ambient conditions: 35°CDB |

Cooling: EW 23°C; LW 18°C; ambient conditions: 35°CDB |

Test at Ta DB/WB 7°C/6°C. According to EN 16147.

Technical specifications				ELBH12E9W + ERRA08EV3	ELBH12E9W + ERRA10EV3	ELBH12E9W + ERRA12EV3
Heating capacity	Min. Nom. Max.	Heating	kW	3.45 (1)		
			kW	6.17 (2)		
			kW	7.95 (1)	9.25 (1)	9.97 (1)
Power input	Min. Nom. Max.	Heating	kW	0.72 (3)		
			kW	1.25 (2)		
			kW	1.69 (3)	2.04 (3)	2.28 (3)
COP			4.92 (2)			

## 2 Specifications

### 2 - 1 Specifications

Technical specifications				ELBH12E9W + ERRA08EV3	ELBH12E9W + ERRA10EV3	ELBH12E9W + ERRA12EV3	
Pump	Type	Grundfos UPM4L K 15-75 130 9 DK1					
	Nominal ESP Heating unit	kPa	67.9 (4)				
Water side Heat exchanger	Water flow rate	Heating Nom.	l/min	18.3			
General	Supplier/Manufacturer details	Name and address		Daikin Europe N.V. - Zandvoordestraat 300, 8400 Oostende, Belgium			
		Name or trademark		Daikin Europe N.V.			
	Product description	Air-to-water heat pump			Yes		
		Brine-to-water heat pump			No		
		Heat pump combination heater			Yes		
		Low-temperature heat pump			No		
		Supplementary heater integrated			Yes		
	LW(A) Sound power level (according to EN14825)	Indoor		dB(A)	44.0		
		Outdoor		dB(A)	56.0		
	Sound condition Ecodesign and energy label				Sound power in heating mode, measured according to the EN12102 under conditions of the EN14825		
Space heating general	Air to water unit	Rated airflow (outdoor)	m <sup>3</sup> /h	3,542			
	Other	Capacity control			Inverter		
		Pck (Crankcase heater mode)		kW	0.000		
		Poff (Off mode)		kW	0.021		
		Psb (Standby mode)		kW	0.021		
		Pto (Thermostat off)		kW	0.024		
	Integrated supplementary heater	Psup		kW	9.0		
		Type of energy input			Electrical		
Space heating climate water outlet 55°C	General	Annual energy consumption	kWh	7,742	7,723	7,510	
		ηs (Seasonal space heating efficiency)	%	130	131	135	
		Prated at -10°C	kW		12.5		
		Qhe Annual energy consumption (GCV)	Gj		28		
		SCOP		3.34		3.44	
		Seasonal space heating eff. class				A++	
		A Condition (-7°CDB/-8°CWB)	Cdh (Degradation heating)				1.0

## 2 Specifications

### 2 - 1 Specifications

Technical specifications				ELBH12E9W + ERRA08EV3	ELBH12E9W + ERRA10EV3	ELBH12E9W + ERRA12EV3	
Space heating 	Average climate	A Condition	COPd			2.26	
		(-7°CDB)	Pdh kW			7.6	
	water outlet	B/-8°CWB)	PERd	%			90.4
		55°C	B Condition	Cdh (Degradation heating)			1.0
		(2°CDB)	COPd			3.39	
		B/1°CWB)	Pdh kW			6.8	
			PERd	%		135.6	
		C Condition	Cdh (Degradation heating)			1.0	
		(7°CDB)	COPd			4.90	
		B/6°CWB)	Pdh kW			4.5	
			PERd	%		196.0	
		D Condition	Cdh (Degradation heating)			1.0	
		(12°CDB)	COPd			6.02	
		B/11°CWB)	Pdh kW			5.2	
			PERd	%		240.8	
		Tol (temperature operating limit)	COPd		1.97		2.00
			Pdh kW		6.9		8.2
		Rated heat output supplementary capacity	PERd	%	78.8		80.0
			TOL °C				-10
			WTOL °C				55
	Tbiv (bivalent temperature)	Psup (at Tdesign -10°C)	kW	5.6		4.3	
		COPd			2.81		2.41
		Pdh kW			8.5		10.0
		PERd	%		112.4		96.4
		Tbiv °C			-2		-5
Cold climate water outlet 55°C	General	Annual energy consumption	kWh	7,303		7,173	
		ηs (Seasonal space heating efficiency)	%	118		121	
		Prated at -22°C	kW			9.0	
		Qhe Annual energy consumption (GCV)	Gj			26	
		A Condition	Cdh (Degradation heating)			1.0	
		(-7°CDB)	COPd			2.52	
		B/-8°CWB)	Pdh kW			5.2	
			PERd	%		100.6	
		B Condition	Cdh (Degradation heating)			1.0	
		(2°CDB)	COPd			3.77	
	B/1°CWB)	Pdh kW			3.3		
		PERd	%		151.0		

## 2 Specifications

### 2 - 1 Specifications

Technical specifications				ELBH12E9W + ERRA08EV3	ELBH12E9W + ERRA10EV3	ELBH12E9W + ERRA12EV3	
Space heating 	Cold climate water outlet 55°C	C Condition (7°CDB/ B/6°CWB)	Cdh (Degradation heating)	1.0			
			COPd	4.81			
			Pdh kW	3.4			
			PERd %	192.2			
		D Condition (12°CDB/ B/11°CWB)	COPd	6.36			
			Pdh kW	4.2			
			PERd %	254.2			
			Tol (temperature operating limit)	COPd	1.43	1.49	1.54
		Warm climate water outlet 55°C	General	Annual energy consumption kWh	3,039		
				ηs (Seasonal space heating efficiency) %	166		
	Prated at 2°C kW			9.6			
	Qhe Annual energy consumption (GCV) GJ			11			
	B Condition (2°CDB/ B/1°CWB)		Cdh (Degradation heating)	1.0			
			COPd	2.57			
			Pdh kW	8.0			
			PERd %	102.6			
	C Condition (7°CDB/ B/6°CWB)		Cdh (Degradation heating)	1.0			
			COPd	3.65			
		Pdh kW	6.7				
		PERd %	146.2				
	D Condition (12°CDB/ B/11°CWB)	Cdh (Degradation heating)	1.0				
		COPd	5.71				
		Pdh kW	3.6				
PERd %		228.3					
Tbiv (bivalent temperature)	COPd	3.02					
Cold climate water outlet 55°C	G Condition (-15°CDB/-)	Tbiv (bivalent temperature)	COPd	1.93	1.96	1.96	
			Pdh kW	6.0	7.2	7.2	
			PERd %	77.2	78.4	78.4	
		Rated heat output supplementary capacity	Psup (at Tdesign -22°C) kW	4.1		2.9	1.8
		Tbiv (bivalent temperature)	COPd	2.17		1.96	1.96
				6.6		7.2	7.2
				86.9		78.4	78.4
				-12		-15	-15
Tol (temperature operating limit)	COPd	4.9		6.1	7.2		
		57.4		59.7	61.7		
		°C		-22	-22	-22	
		°C		55	55	55	

## 2 Specifications



### 2 - 1 Specifications

Technical specifications					ELBH12E9W + ERRA08EV3	ELBH12E9W + ERRA10EV3	ELBH12E9W + ERRA12EV3	
Space heating 	Warm climate water outlet 55°C	Tbiv	Pdh	kW	8.4			
		(bivalent temperature)	PERd	%	120.9			
			Tbiv	°C	4			
	Average climate water outlet 35°C	General	Annual energy consumption		kWh	3,659		3,637
			ηs (Seasonal space heating efficiency)		%	184		186
			Prated at -10°C		kW	8.3		
			Qhe Annual energy consumption (GCV)		Gj	13		
			SCOP			4.69		4.71
			Seasonal space heating eff. class			A+++		
			A Condition (-7°CDB/ -8°CWB)	COPd				3.10
	Pdh				kW	7.5		
	B Condition (2°CDB/ 1°CWB)	Cdh (Degradation heating)				124.1		
			COPd			4.76		
			Pdh		kW	4.4		
	C Condition (7°CDB/ 6°CWB)	Cdh (Degradation heating)				190.4		
			COPd			6.14		
			Pdh		kW	4.3		
	D Condition (12°CDB/ 11°CWB)	Cdh (Degradation heating)				245.8		
			COPd			7.84		
			Pdh		kW	6.6		
	ToI (temperature operating limit)	COPd				313.4		
			Pdh		kW	2.80		
			PERd		%	112.2		
	Tbiv (bivalent temperature)	TOL				-10		
			WTOL		°C	35		
			COPd			3.10		
	Rated heat output supplementary capacity	Pdh				7.5		
PERd				%	124.1			
Tbiv				°C	-7			
Cold climate water outlet 35°C	Psup (at Tdesign -10°C)				1.4			
		Annual energy consumption		kWh	5,554	5,401	5,387	
		ηs (Seasonal space heating efficiency)		%	157	161	162	
	Prated at -22°C			kW	9			

# 2 Specifications

## 2 - 1 Specifications

2

Technical specifications				ELBH12E9W + ERRA08EV3	ELBH12E9W + ERRA10EV3	ELBH12E9W + ERRA12EV3		
Space heating 	Cold climate water outlet 35°C	General	Qhe Annual energy consumption (GCV)	Gj	20.0		19.4	
			A Condition (-7°CDB)	COPd		3.36		
				Pdh	kW	5.4		
				PERd	%	134.5		
			B Condition (2°CDB)	Cdh (Degradation heating)		1.0		
				COPd		5.21		
				Pdh	kW	3.6		
				PERd	%	208.4		
			C Condition (7°CDB)	Cdh (Degradation heating)		1.0		
				COPd		6.29		
				Pdh	kW	5.3		
				PERd	%	251.7		
			D Condition (12°CDB)	Cdh (Degradation heating)		1.0		
				COPd		7.69		
				Pdh	kW	6.6		
				PERd	%	307.6		
			Tol (temperature operating limit)	COPd		2.04	2.07	2.09
				Pdh	kW	4.9	5.9	6.4
				PERd	%	81.6	82.9	83.6
				TOL	°C		-22	
				WTOL	°C		35	
			G Condition (-15°CDB)	COPd		2.60		2.56
				Pdh	kW	6.0		7.0
	PERd	%	103.8		102.6			
Tbiv (bivalent temperature)	COPd		2.86		2.56			
	Pdh	kW	6.5		7.0			
	PERd	%	114.4		102.6			
	Tbiv	°C	-12		-15			
Rated heat output supplementary capacity	Psup (at Tdesign -22°C)	kW	4.1	3.1	2.6			
Warm climate water outlet 35°C	General	Annual energy consumption	kWh	2,027				
		ηs (Seasonal space heating efficiency)	%	224				
		Prated at 2°C	kW	8.6				
		Qhe Annual energy consumption (GCV)	Gj	7				
		B Condition (2°CDB)	Cdh (Degradation heating)		1.0			
			COPd		4.06			
			Pdh	kW	6.8			
			PERd	%	162.4			
		C Condition (7°CDB)	Cdh (Degradation heating)		1.0			
			COPd		5.65			
	Pdh	kW	5.5					
	PERd	%	226.0					
Tbiv (bivalent temperature)	COPd		4.73					
	Pdh	kW	6.8					
	PERd	%	189.2					
	Tbiv	°C	5					
D Condition (12°CDB)	Cdh (Degradation heating)		1.0					
	COPd		7.52					
	Pdh	kW	6.1					
	PERd	%	300.8					
Space heating 	Warm climate water outlet 35°C	C Condition (7°CDB)	Cdh (Degradation heating)		1.0			
				COPd		5.65		
				Pdh	kW	5.5		
				PERd	%	226.0		
			Tbiv (bivalent temperature)	COPd		4.73		
				Pdh	kW	6.8		
				PERd	%	189.2		
				Tbiv	°C	5		
			D Condition (12°CDB)	Cdh (Degradation heating)		1.0		
				COPd		7.52		
	Pdh	kW	6.1					
	PERd	%	300.8					

(1)Capacity according to standard EN14511 and valid for heated water range dT = 3~8°C at Ta 7°C |  
 (2)Condition: Ta DB/WB 7°C/6°C - LWC 35°C (DT = 5°C) |  
 (3)Power input is total input of indoor and outdoor units, including the circulation pump; according to EN14511 |  
 (4)DB/WB 7°C/6°C - LWC 35°C (dT=5°C) with pump at full speed |  
 Cooling: EW 12°C; LW 7°C; ambient conditions: 35°CDB |  
 Cooling: EW 23°C; LW 18°C; ambient conditions: 35°CDB |  
 Test at Ta DB/WB 7°C/6°C. According to EN 16147.

Technical specifications				ELBX12E6V + ERRA08EV3	ELBX12E6V + ERRA10EV3	ELBX12E6V + ERRA12EV3
Heating capacity	Min.		kW	3.45 (1)		
	Nom.		kW	6.17 (2)		
	Max.		kW	7.95 (1)		9.97 (1)
Cooling capacity	Nom.		kW	6.81 (3) / 6.47 (4)	7.97 (3) / 6.47 (4)	8.62 (3) / 6.47 (4)
Power input	Heating	Min.	kW	0.72 (5)		
		Nom.	kW	1.25 (2)		
		Max.	kW	1.69 (5)	2.04 (5)	2.28 (5)
	Cooling	Nom.	kW	2.15 (3) / 1.16 (4)	2.66 (3) / 1.16 (4)	2.96 (3) / 1.16 (4)
					4.92 (2)	

## 2 Specifications

### 2 - 1 Specifications

Technical specifications					ELBX12E6V + ERRA08EV3	ELBX12E6V + ERRA10EV3	ELBX12E6V + ERRA12EV3
EER					3.17 (3) / 5.56 (4)	3.00 (3) / 5.56 (4)	2.91 (3) / 5.56 (4)
Pump	Type				Grundfos UPM4L K 15-75 130 9 DK1		
	Nominal ESP unit	Heating		kPa	67.9 (6)		
Water side Heat exchanger	Water flow rate	Heating	Nom.	l/min	18.3		
General	Supplier/Manufacturer details	Name and address			Daikin Europe N.V. - Zandvoordestraat 300, 8400 Oostende, Belgium		
		Name or trademark			Daikin Europe N.V.		
	Product description	Air-to-water heat pump			Yes		
		Brine-to-water heat pump			No		
		Heat pump combination heater			Yes		
		Low-temperature heat pump			No		
		Supplementary heater integrated			Yes		
		Water-to-water heat pump			No		
LW(A) Sound power level (according to EN14825)	Indoor			dB(A)	44.0		
LW(A) Sound power level (according to EN14825)	Outdoor			dB(A)	56.0		
Sound condition Ecodesign and energy label					Sound power in heating mode, measured according to the EN12102 under conditions of the EN14825		
Space heating general	Air to water unit	Rated airflow (outdoor)			m <sup>3</sup> /h	3,542	
		Other	Capacity control				Inverter
	Pck (Crankcase heater mode)			kW	0.000		
	Poff (Off mode)			kW	0.021		
	Psb (Standby mode)			kW	0.021		
	Pto (Thermostat off)			kW	0.024		
	Integrated supplementary heater	Psup			kW	6.0	
		Type of energy input				Electrical	
Space heating 	Average climate water outlet 55°C	General	Annual energy consumption	kWh	7,664	7,645	7,433
			ηs (Seasonal space heating efficiency)	%	132		136
			Prated at -10°C	kW	12.5		
			Qhe Annual energy consumption (GCV)	Gj	28		27

## 2 Specifications

### 2 - 1 Specifications

Technical specifications				ELBX12E6V + ERRA08EV3	ELBX12E6V + ERRA10EV3	ELBX12E6V + ERRA12EV3	
Space heating Average climate water outlet 55°C	General	SCOP		3.37	3.38	3.47	
		Seasonal space heating eff. class			A++		
	A Condition (-7°CDB/-8°CWB)	Cdh (Degradation heating)			1.0		
		COPd			2.26		
		Pdh kW			7.6		
	B Condition (2°CDB/1°CWB)	PERd %			90.4		
		Cdh (Degradation heating)			1.0		
		COPd			3.39		
	C Condition (7°CDB/6°CWB)	Pdh kW			6.8		
		PERd %			135.6		
		Cdh (Degradation heating)			1.0		
	D Condition (12°CDB/11°CWB)	COPd			4.90		
		Pdh kW			4.5		
		PERd %			196.0		
	Tol (temperature operating limit)	Cdh (Degradation heating)			1.0		
		COPd			6.02		
		Pdh kW			5.2		
		PERd %			240.8		
		TOL °C			-10		
	Rated heat output supplementary capacity	WTOL °C			55		
		Psup (at Tdesign -10°C) kW		5.6		4.3	
		Tbiv (bivalent temperature)	COPd		2.81		2.41
			Pdh kW		8.5		10.0
		PERd %			112.4		96.4
	Tbiv °C			-2		-5	
	Cold climate water outlet 55°C	General	Annual energy consumption kWh		7,257	7,127	7,100
			ηs (Seasonal space heating efficiency) %		119		122
Prated at -22°C kW						9.0	
A Condition (-7°CDB/-8°CWB)		Qhe Annual energy consumption (GCV) GJ				26	
		Cdh (Degradation heating)			1.0		
		COPd			2.52		
B Condition (2°CDB/1°CWB)		Pdh kW			5.2		
		PERd %			100.6		
		Cdh (Degradation heating)			1.0		

## 2 Specifications

### 2 - 1 Specifications

Technical specifications				ELBX12E6V + ERRA08EV3	ELBX12E6V + ERRA10EV3	ELBX12E6V + ERRA12EV3	
Space heating 	Cold climate water outlet 55°C	B Condition (2°CDB)	COPd	3.77			
			Pdh	3.3			
			PERd	151.0			
		C Condition (7°CDB)	Cd <sub>h</sub> (Degradation heating)		1.0		
			COPd	4.81			
			Pdh	3.4			
		D Condition (12°CDB)	PERd		192.2		
			COPd	6.36			
			Pdh	4.2			
	Tol (tem- perature operating limit)	PERd		254.2			
		COPd	1.43	1.49	1.54		
		Pdh	4.9	6.1	7.2		
	G Condition (-15°CDB/-)	PERd		59.7			
		TOL	-22				
		WTOL	55				
	T <sub>biv</sub> (bivalent tempera- ture)	COPd		1.93			
		Pdh	6.0	7.2	7.2		
		PERd	77.2	78.4	78.4		
	Rated heat output sup- plementary capacity	COPd		2.17			
		Pdh	6.6	7.2	7.2		
		PERd	86.9	78.4	78.4		
	Warm climate water outlet 55°C	T <sub>biv</sub>		-12			
		P <sub>sup</sub> (at T <sub>design</sub> -22°C)		4.1	2.9	1.8	
		General		2,946			
	General	Annual energy consumption		2,946			
		η <sub>s</sub> (Seasonal space heating efficiency)		171			
		Prated at 2°C		9.6			
Q <sub>he</sub> Annual energy consumption (GCV)		11					
B Condition (2°CDB)		Cd <sub>h</sub> (Degradation heating)		1.0			
		COPd	2.57				
		Pdh	8.0				
C Condition (7°CDB)		PERd		102.6			
		Cd <sub>h</sub> (Degradation heating)	1.0				
		COPd	3.65				
D Condition (12°CDB/11°CWB)		Pdh		6.7			
		PERd	146.2				
		Cd <sub>h</sub> (Degradation heating)	1.0				
COPd		5.71					

## 2 Specifications

### 2 - 1 Specifications

Technical specifications				ELBX12E6V + ERRA08EV3	ELBX12E6V + ERRA10EV3	ELBX12E6V + ERRA12EV3		
Space heating	Warm climate water outlet 55°C	D Condition (12°CDB/11°CWB)	Pdh	kW			3.6	
			PERd	%			228.3	
Average climate water outlet 35°C	General		Tbiv	COPd			3.02	
			Pdh	kW			8.4	
			PERd	%			120.9	
			Tbiv	°C			4	
			Annual energy consumption	kWh			3,582	3,560
			ηs (Seasonal space heating efficiency)	%			188	190
			Prated at -10°C	kW			8.3	
			Qhe Annual energy consumption (GCV)	Gj			13	
			SCOP				4.79	4.82
			Seasonal space heating eff. class				A+++	
A Condition (-7°CDB/-8°CWB)		COPd				3.10		
		Pdh	kW			7.5		
B Condition (2°CDB/1°CWB)		PERd	%			124.1		
		Cdh (Degradation heating)				1.0		
		COPd				4.76		
C Condition (7°CDB/6°CWB)		Pdh	kW			4.4		
		PERd	%			190.4		
		Cdh (Degradation heating)				1.0		
D Condition (12°CDB/11°CWB)		COPd				6.14		
		Pdh	kW			4.3		
		PERd	%			245.8		
Tol (temperature operating limit)		Cdh (Degradation heating)				1.0		
		COPd				7.84		
		Pdh	kW			6.6		
		PERd	%			313.4		
Tbiv (bivalent temperature)		COPd				2.80	2.77	
		Pdh	kW			6.9	8.1	
		PERd	%			112.2	110.8	
		TOL	°C			-10		
Rated heat output supplementary capacity		WTOL	°C			35		
		COPd				3.10	2.77	
		Pdh	kW			7.5	8.1	
		PERd	%			124.1	110.8	
	Tbiv	°C			-7	-10		
	Psup (at Tdesign -10°C)	kW			1.4	0.0		

## 2 Specifications

### 2 - 1 Specifications

Technical specifications				ELBX12E6V + ERRA08EV3	ELBX12E6V + ERRA10EV3	ELBX12E6V + ERRA12EV3		
Space heating 	Cold climate water outlet 35°C	General	Annual energy consumption	kWh	5,507	5,355	5,340	
			$\eta_s$ (Seasonal space heating efficiency)	%	158	163		
			Prated at -22°C	kW	9			
			Qhe Annual energy consumption (GCV)	Gj	19.8	19.3	19.2	
		A Condition (-7°CDB- B/-8°CWB)	COPd			3.36		
				Pdh	kW		5.4	
				PERd	%		134.5	
		B Condition (2°CDB- B/1°CWB)	Cdh (Degradation heating)			1.0		
				COPd		5.21		
				Pdh	kW		3.6	
			PERd			208.4		
				Cdh (Degradation heating)		1.0		
				COPd		6.29		
		C Condition (7°CDB- B/6°CWB)	Pdh			5.3		
				PERd	%		251.7	
				Cdh (Degradation heating)		1.0		
		D Condition (12°CDB- B/11°CWB)	COPd			7.69		
				Pdh	kW		6.6	
				PERd	%		307.6	
		Tol (tem- perature operating limit)	COPd		2.04	2.07	2.09	
				Pdh	kW	4.9	5.9	6.4
				PERd	%	81.6	82.9	83.6
				TOL	°C		-22	
				WTOL	°C		35	
G Condition (-15°CDB/-)	COPd		2.60		2.56			
		Pdh	kW	6.0		7.0		
		PERd	%	103.8		102.6		
Tbiv (bivalent tempera- ture)	COPd		2.86		2.56			
		Pdh	kW	6.5		7.0		
		PERd	%	114.4		102.6		
		Tbiv	°C	-12		-15		
Rated heat output sup- plementary capacity	Psup (at Tdesign -22°C)		4.1	3.1	2.6			
Warm climate water outlet 35°C	General	Annual energy consumption	kWh	1,934				
		$\eta_s$ (Seasonal space heating efficiency)	%	235				
		Prated at 2°C	kW	8.6				
		Qhe Annual energy consumption (GCV)	Gj	7				
		B Condition (2°CDB- B/1°CWB)	Cdh (Degradation heating)			1.0		
Space heating 	Warm climate water outlet 35°C	B Condition (2°CDB- B/1°CWB)	COPd		4.06			
			Pdh	kW		6.8		
			PERd	%		162.4		
		C Condition (7°CDB- B/6°CWB)	Cdh (Degradation heating)			1.0		
				COPd		5.65		
				Pdh	kW		5.5	
			PERd			226.0		
				COPd		4.73		
				Pdh	kW		6.8	
		Tbiv (bivalent tempera- ture)	PERd			189.2		
				Tbiv	°C		5	
				Cdh (Degradation heating)		1.0		
		D Condition (12°CDB- B/11°CWB)	COPd			7.52		
				Pdh	kW		6.1	
				PERd	%		300.8	

(1)Capacity according to standard EN14511 and valid for heated water range dT = 3–8°C at Ta 7°C |

(2)Condition: Ta DB/WB 7°C/6°C - LWC 35°C (DT = 5°C) |

(3)Cooling: EW 12°C; LW 7°C; ambient conditions: 35°CDB |

(4)Cooling: EW 23°C; LW 18°C; ambient conditions: 35°CDB |

(5)Power input is total input of indoor and outdoor units, including the circulation pump; according to EN14511 |

(6)DB/WB 7°C/6°C - LWC 35°C (dT=5°C) with pump at full speed |

Test at Ta DB/WB 7°C/6°C. According to EN 16147.

## 2 Specifications

### 2 - 1 Specifications

2

Technical specifications					ELBX12E9W + ERRA08EV3	ELBX12E9W + ERRA10EV3	ELBX12E9W + ERRA12EV3	
Heating capacity	Min.			kW	3.45 (1)			
	Nom.			kW	6.17 (2)			
	Max.			kW	7.95 (1)	9.25 (1)	9.97 (1)	
Cooling capacity	Nom.			kW	6.81 (3) / 6.47 (4)	7.97 (3) / 6.47 (4)	8.62 (3) / 6.47 (4)	
Power input	Heating	Min.		kW	0.72 (5)			
		Nom.		kW	1.25 (2)			
		Max.		kW	1.69 (5)	2.04 (5)	2.28 (5)	
	Cooling	Nom.		kW	2.15 (3) / 1.16 (4)	2.66 (3) / 1.16 (4)	2.96 (3) / 1.16 (4)	
COP					4.92 (2)			
EER					3.17 (3) / 5.56 (4)			
Pump	Type				Grundfos UPM4L K 15-75 130 9 DK1			
	Nominal ESP unit	Heating		kPa	67.9 (6)			
Water side Heat exchanger	Water flow rate	Heating	Nom.	l/min	18.3			
		General		Supplier/Manufacturer details	Daikin Europe N.V. - Zandvoordestraat 300, 8400 Oostende, Belgium Daikin Europe N.V.			
Product description	Air-to-water heat pump				Yes			
	Brine-to-water heat pump				No			
	Heat pump combination heater				Yes			
	Low-temperature heat pump				No			
	Supplementary heater integrated				Yes			
	Water-to-water heat pump				No			
LW(A) Sound power level (according to EN14825)	Indoor			dB(A)	44.0			
	Outdoor			dB(A)	56.0			
Sound condition Ecodesign and energy label					Sound power in heating mode, measured according to the EN12102 under conditions of the EN14825			
Space heating general	Air to water unit	Rated airflow (outdoor)		m <sup>3</sup> /h	3,542			
		Other	Capacity control		Inverter			
		Pck (Crankcase heater mode)		kW	0.000			
		Poff (Off mode)		kW	0.021			
		Psb (Standby mode)		kW	0.021			
		Pto (Thermostat off)		kW	0.024			
	Integrated supplementary heater	Psup		kW	9.0			
Space heating 	Average climate water outlet 55°C	General	Annual energy consumption	kWh	7,664	7,645	7,433	
			ηs (Seasonal space heating efficiency)	%	132			
			Prated at -10°C		kW	12.5		
			Qhe Annual energy consumption (GCV)		Gj	28		27

## 2 Specifications

### 2 - 1 Specifications

Technical specifications				ELBX12E9W + ERRA08EV3	ELBX12E9W + ERRA10EV3	ELBX12E9W + ERRA12EV3		
Space heating 	Average climate water outlet 55°C	General	SCOP	3.37	3.38	3.47		
			Seasonal space heating eff. class		A++			
		A Condition (-7°CDB/-8°CWB)	Cdh (Degradation heating)		1.0			
			COPd		2.26			
			Pdh kW		7.6			
		B Condition (2°CDB/1°CWB)	PERd %		90.4			
			Cdh (Degradation heating)		1.0			
			COPd		3.39			
		C Condition (7°CDB/6°CWB)	Pdh kW		6.8			
			PERd %		135.6			
			Cdh (Degradation heating)		1.0			
		D Condition (12°CDB/11°CWB)	COPd		4.90			
			Pdh kW		4.5			
			PERd %		196.0			
		Tol (temperature operating limit)	Cdh (Degradation heating)		1.0			
			COPd		6.02			
			Pdh kW		5.2			
			PERd %		240.8			
			TOL °C		-10			
		Rated heat output supplementary capacity	WTOL °C		55			
			Psup (at Tdesign -10°C) kW		5.6	4.3		
			Tbiv (bivalent temperature)	COPd		2.81	2.41	
				Pdh kW		8.5	10.0	
			PERd %			112.4	96.4	
		Tbiv °C			-2	-5		
		Cold climate water outlet 55°C	General	Annual energy consumption	kWh	7,257	7,127	7,100
			ns (Seasonal space heating efficiency)		%	119	122	
Prated at -22°C	kW				9.0			
Qhe Annual energy consumption (GCV)			Gj		26			
	Cdh (Degradation heating)			1.0				
A Condition (-7°CDB/-8°CWB)	COPd			2.52				
	Pdh kW			5.2				
	PERd %			100.6				
B Condition (2°CDB/1°CWB)	Cdh (Degradation heating)			1.0				

## 2 Specifications

### 2 - 1 Specifications

2

Technical specifications				ELBX12E9W + ERRA08EV3	ELBX12E9W + ERRA10EV3	ELBX12E9W + ERRA12EV3	
Space heating 	Cold climate water outlet 55°C	B Condition	COPd			3.77	
		(2°CDB)	Pdh	kW			3.3
		B/1°CWB)	PERd	%			151.0
		C Condition	Cdh (Degradation heating)				1.0
		(7°CDB)	COPd				4.81
		B/6°CWB)	Pdh	kW			3.4
			PERd	%			192.2
		D Condition	COPd				6.36
		(12°CDB)	Pdh	kW			4.2
		B/11°CWB)	PERd	%			254.2
		Tol (tem-	COPd		1.43	1.49	1.54
		perature	Pdh	kW	4.9	6.1	7.2
		operating	PERd	%	57.4	59.7	61.7
		limit)	TOL	°C			-22
			WTOL	°C			55
		G Condition	COPd		1.93		1.96
		(-15°CDB/-)	Pdh	kW	6.0		7.2
			PERd	%	77.2		78.4
		Tbiv	COPd		2.17		1.96
		(bivalent	Pdh	kW	6.6		7.2
	tempera-	PERd	%	86.9		78.4	
	ture)	Tbiv	°C	-12		-15	
	Rated heat	Psup (at Tdesign -22°C)	kW	4.1	2.9	1.8	
	output sup-						
	plementary						
	capacity						
Warm climate water outlet 55°C	General	Annual energy	kWh	2,946			
		consumption					
		ηs (Seasonal space	%	171			
		heating efficiency)					
		Prated at 2°C	kW	9.6			
		Qhe Annual energy	Gj	11			
		consumption (GCV)					
		B Condition	Cdh (Degradation heating)				1.0
		(2°CDB)	COPd				2.57
		B/1°CWB)	Pdh	kW			8.0
			PERd	%			102.6
		C Condition	Cdh (Degradation heating)				1.0
		(7°CDB)	COPd				3.65
		B/6°CWB)	Pdh	kW			6.7
		PERd	%			146.2	
	D Condition	Cdh (Degradation heating)				1.0	
	(12°CDB/11°CWB)	COPd				5.71	

## 2 Specifications

### 2 - 1 Specifications

Technical specifications				ELBX12E9W + ERRA08EV3	ELBX12E9W + ERRA10EV3	ELBX12E9W + ERRA12EV3		
Space heating 	Warm climate water outlet 55°C	D Condition (12°CDB/11°CWB)	Pdh	kW	3.6			
			PERd	%	228.3			
			Tbiv	COPd		3.02		
	Average climate water outlet 35°C	General		Pdh	kW	8.4		
				PERd	%	120.9		
				Tbiv	°C	4		
				Annual energy consumption	kWh	3,582	3,560	
				ηs (Seasonal space heating efficiency)	%	188	190	
				Prated at -10°C	kW	8.3		
				Qhe Annual energy consumption (GCV)	Gj	13		
				SCOP		4.79	4.82	
				Seasonal space heating eff. class		A+++		
			A Condition (-7°CDB/8°CWB)		COPd		3.10	
		Pdh		kW	7.5			
		PERd		%	124.1			
	B Condition (2°CDB/1°CWB)		Cdh (Degradation heating)		1.0			
			COPd		4.76			
			Pdh	kW	4.4			
	C Condition (7°CDB/6°CWB)		PERd	%	190.4			
			Cdh (Degradation heating)		1.0			
			COPd		6.14			
	D Condition (12°CDB/11°CWB)		Pdh	kW	4.3			
			PERd	%	245.8			
			Cdh (Degradation heating)		1.0			
	Tol (temperature operating limit)		COPd		2.80	2.77		
			Pdh	kW	6.9	8.1		
			PERd	%	112.2	110.8		
		TOL	°C	-10				
		WTOL	°C	35				
Tbiv (bivalent temperature)		COPd		3.10	2.77			
		Pdh	kW	7.5	8.1			
		PERd	%	124.1	110.8			
		Tbiv	°C	-7	-10			
Rated heat output supplementary capacity		Psup (at Tdesign -10°C)	kW	1.4	0.0			

# 2 Specifications

## 2 - 1 Specifications

2

Technical specifications				ELBX12E9W + ERRA08EV3	ELBX12E9W + ERRA10EV3	ELBX12E9W + ERRA12EV3		
Space heating	Cold climate water outlet 35°C	General	Annual energy consumption	kWh	5,507	5,355	5,340	
			ηs (Seasonal space heating efficiency)	%	158	163		
			Prated at -22°C	kW	9			
			Qhe Annual energy consumption (GCV)	Gj	19.8	19.3	19.2	
		A Condition (-7°CDB)	B/1°CWB	COPd		3.36		
				Pdh	kW	5.4		
				PERd	%	134.5		
		B Condition (2°CDB)	B/1°CWB	Cdh (Degradation heating)		1.0		
				COPd		5.21		
				Pdh	kW	3.6		
		C Condition (7°CDB)	B/6°CWB	PERd	%	208.4		
				Cdh (Degradation heating)		1.0		
				COPd		6.29		
		D Condition (12°CDB)	B/11°CWB	Pdh	kW	5.3		
				PERd	%	251.7		
				Cdh (Degradation heating)		1.0		
		Tol (temperature operating limit)		COPd		2.04	2.07	2.09
				Pdh	kW	4.9	5.9	6.4
				PERd	%	81.6	82.9	83.6
				TOL	°C	-22		
				WTOL	°C	35		
		G Condition (-15°CDB/-)		COPd		2.60	2.56	
				Pdh	kW	6.0	7.0	
PERd	%			103.8	102.6			
Tbiv (bivalent temperature)		COPd		2.86	2.56			
		Pdh	kW	6.5	7.0			
		PERd	%	114.4	102.6			
		Tbiv	°C	-12	-15			
Rated heat output supplementary capacity		Psup (at Tdesign -22°C)	kW	4.1	3.1	2.6		
Warm climate water outlet 35°C	General	Annual energy consumption	kWh	1,934				
		ηs (Seasonal space heating efficiency)	%	235				
		Prated at 2°C	kW	8.6				
		Qhe Annual energy consumption (GCV)	Gj	7				
		Cdh (Degradation heating)		1.0				
Space heating	Warm climate water outlet 35°C	B Condition (2°CDB)	B/1°CWB	COPd		4.06		
				Pdh	kW	6.8		
				PERd	%	162.4		
		C Condition (7°CDB)	B/6°CWB	Cdh (Degradation heating)		1.0		
				COPd		5.65		
				Pdh	kW	5.5		
		D Condition (12°CDB)	B/11°CWB	PERd	%	226.0		
				COPd		4.73		
				Pdh	kW	6.8		
		Tbiv (bivalent temperature)		PERd	%	189.2		
Tbiv	°C			5				
Cdh (Degradation heating)				1.0				
D Condition (12°CDB)	B/11°CWB	COPd		7.52				
		Pdh	kW	6.1				
		PERd	%	300.8				

(1)Capacity according to standard EN14511 and valid for heated water range dT = 3–8°C at Ta 7°C |  
 (2)Condition: Ta DB/WB 7°C/6°C - LWC 35°C (DT = 5°C) |  
 (3)Cooling: EW 12°C; LW 7°C; ambient conditions: 35°CDB |  
 (4)Cooling: EW 23°C; LW 18°C; ambient conditions: 35°CDB |  
 (5)Power input is total input of indoor and outdoor units, including the circulation pump; according to EN14511 |  
 (6)DB/WB 7°C/6°C - LWC 35°C (dT=5°C) with pump at full speed |  
 Test at Ta DB/WB 7°C/6°C. According to EN 16147.

## 2 Specifications

### 2 - 1 Specifications

Technical specifications				ELSH12P30E + ERRA08EV3	ELSH12P50E + ERRA08EV3	ELSH12P30E + ERRA10EV3	ELSH12P50E + ERRA10EV3	ELSH12P30E + ERRA12EV3	ELSH12P50E + ERRA12EV3	
Heating capacity	Min.		kW	3.45 (1)						
	Nom.		kW	6.17 (2)						
	Max.		kW	7.95 (1)		9.25 (1)		9.97 (1)		
Power input	Heating	Min.	kW	0.72 (3)						
		Nom.	kW	1.25 (2)						
		Max.	kW	1.69 (3)		2.04 (3)		2.28 (3)		
	Domestic hot water from 10°C to 50°C	Nom.	kWh	3.57 (4)	4.82 (4)	3.57 (4)	4.82 (4)	3.57 (4)	4.82 (4)	
Heat up time from 10°C to 50°C			hr	2h29min	3h45min	2h29min	3h45min	2h29min	3h45min	
COP				4.92 (2)						
Pump	Type	Grundfos UPM4L K 20-75 CHBL 3 RT								
	Nominal ESP unit	Heating	kPa	55.4 (5)						
Water side Heat exchanger	Water flow rate	Heating	Nom.	l/min						
General	Supplier/Manufacturer details	Name and address		Daikin Europe N.V. - Zandvoordestraat 300, 8400 Oostende, Belgium						
		Name or trademark		Daikin Europe N.V.						
	Product description	Air-to-water heat pump		Yes						
		Brine-to-water heat pump		No						
		Heat pump combination heater		Yes						
		Low-temperature heat pump		No						
		Supplementary heater integrated		No						
		Water-to-water heat pump		No						
	LW(A) Sound power level (according to EN14825)	Indoor		dB(A)	44.7					
	LW(A) Sound power level (according to EN14825)	Outdoor		dB(A)	56.0					
Sound condition Ecodesign and energy label				Sound power in heating mode, measured according to the EN12102 under conditions of the EN14825						
Space heating general	Air to water unit	Rated airflow (outdoor)		m <sup>3</sup> /h						
				3,542						
	Other	Capacity control		Inverter						
		Pck (Crankcase heater mode)		kW						
		Poff (Off mode)		kW						
		Psb (Standby mode)		kW						
Pto (Thermostat off)		kW								
Domestic hot water heating	General	Declared load profile		L	XL	L	XL	L	XL	
		Average climate	AEC (Annual electricity consumption)	kWh	885	1,273	885	1,273	885	1,273
	Climate	COPdhw		2.75						
		Heat up time		2h 29min	3h 28min	2h 29min	3h 28min	2h 29min	3h 28min	
		η <sub>wh</sub> (water heating efficiency)		%						
		Qelec (Daily electricity consumption)		kWh						
		Reference hot water temperature		°C						
				47.2						
	Domestic hot water heating	Average climate	Stand-by power input		W					
					38.1					
Cold climate		Water heating energy efficiency class		A+						
		AEC (Annual electricity consumption)	kWh	1,183	1,503	1,183	1,503	1,183	1,503	
		COPdhw		2.07						
		Heat up time		2h 23min	3h 37 min	2h 23min	3h 37 min	2h 23min	3h 37 min	
		η <sub>wh</sub> (water heating efficiency)		%						
				87						
		Qelec (Daily electricity consumption)		kWh						
				5.640						
Warm climate	Reference hot water temperature		°C							
			46.3							
	Stand-by power input		W							
			46.4							
	AEC (Annual electricity consumption)	kWh	782	1,051	782	1,051	782	1,051		
	COPdhw		3.10							
Heat up time		2h 18min	3h 17min	2h 18min	3h 17min	2h 18min	3h 17min			
η <sub>wh</sub> (water heating efficiency)		%								
		131								
Qelec (Daily electricity consumption)		kWh								
		3.760								
Reference hot water temperature		°C								
		47.2								
Stand-by power input		W								
		35.8								

## 2 Specifications

### 2 - 1 Specifications

Technical specifications				ELSH12P30E + ERRA08EV3	ELSH12P50E + ERRA08EV3	ELSH12P30E + ERRA10EV3	ELSH12P50E + ERRA10EV3	ELSH12P30E + ERRA12EV3	ELSH12P50E + ERRA12EV3		
Space heating	Average climate water outlet 55°C	General	Annual energy consumption	kWh	7,742		7,723		7,510		
			ηs (Seasonal space heating efficiency)	%	130		131		135		
			Prated at -10°C	kW			12.5				
			Qhe Annual energy consumption (GCV)	Gj		28			27		
			SCOP			3.34			3.44		
			Seasonal space heating eff. class				A++				
			A Condition (-7°CDB)	Cdh (Degradation heating)	COPd			1.0			
					Pdh	kW		2.26			
					PERd	%		7.6			
					PERd	%		90.4			
			B Condition (2°CDB)	Cdh (Degradation heating)	COPd			1.0			
					Pdh	kW		3.39			
					PERd	%		6.8			
					PERd	%		135.6			
			C Condition (7°CDB)	Cdh (Degradation heating)	COPd			1.0			
					Pdh	kW		4.90			
					PERd	%		4.5			
					PERd	%		196.0			
			D Condition (12°CDB)	Cdh (Degradation heating)	COPd			1.0			
					Pdh	kW		6.02			
PERd	%				5.2						
PERd	%				240.8						
Space heating	Average climate water outlet 55°C	General	Tol (temperature operating limit)	°C							
			WTOL	°C			-10				
			Rated heat output supplementary capacity	kW		5.6			4.3		
			Tbiv (bivalent temperature)	COPd		1.97			2.00		
				Pdh	kW	6.9			8.2		
				PERd	%	78.8			80.0		
				Tbiv	°C				-5		
			Cold climate water outlet 55°C	General	Annual energy consumption	kWh	7,303		7,173		7,146
					ηs (Seasonal space heating efficiency)	%	118			121	
					Prated at -22°C	kW			9.0		
Qhe Annual energy consumption (GCV)	Gj					26					
A Condition (-7°CDB)	Cdh (Degradation heating)	COPd					1.0				
		Pdh			kW		2.52				
		PERd			%		5.2				
		PERd			%		100.6				
B Condition (2°CDB)	Cdh (Degradation heating)	COPd					1.0				
		Pdh			kW		3.77				
		PERd	%		3.3						
		PERd	%		151.0						
C Condition (7°CDB)	Cdh (Degradation heating)	COPd			1.0						
		Pdh	kW		4.81						
		PERd	%		3.4						
		PERd	%		192.2						
D Condition (12°CDB)	Cdh (Degradation heating)	COPd			6.36						
		Pdh	kW		4.2						
		PERd	%		254.2						
		Tol (temperature operating limit)	°C								
G Condition (-15°CDB/-)	Cdh (Degradation heating)	COPd		1.43		1.49		1.54			
		Pdh	kW	4.9		6.1		7.2			
		PERd	%	57.4		59.7		61.7			
		TOL	°C			-22					
G Condition (-15°CDB/-)	Cdh (Degradation heating)	WTOL	°C			55					
		COPd		1.93			1.96				
G Condition (-15°CDB/-)	Cdh (Degradation heating)	Pdh	kW	6.0			7.2				

## 2 Specifications

### 2 - 1 Specifications

Technical specifications				ELSH12P30E + ERRA08EV3	ELSH12P50E + ERRA08EV3	ELSH12P30E + ERRA10EV3	ELSH12P50E + ERRA10EV3	ELSH12P30E + ERRA12EV3	ELSH12P50E + ERRA12EV3
Space heating 	Cold climate water outlet 55°C	G Condition (-15°CDB/-)	PERd	%	77.2			78.4	
			Tbiv	COPd		2.17		1.96	
		(bivalent tempera- ture)	Pdh	kW	6.6		7.2		
			PERd	%	86.9		78.4		
		Tbiv	°C	-12		-15			
		Rated heat output sup- plementary capacity	Psup (at Tdesign -22°C)	kW	4.1		2.9		1.8
	Warm climate water outlet 55°C	General	Annual energy consumption	kWh			3,039		
			ηs (Seasonal space heating efficiency)	%			166		
			Prated at 2°C	kW			9.6		
			Qhe Annual energy consumption (GCV)	Gj			11		
			B Condition (2°CDB- B/1°CWB)	Cdh (Degradation heating)			1.0		
			COPd			2.57			
			Pdh	kW		8.0			
			PERd	%		102.6			
		C Condition (7°CDB- B/6°CWB)	Cdh (Degradation heating)			1.0			
COPd					3.65				
Pdh			kW		6.7				
		PERd	%		146.2				
D Condition (12°CDB- B/11°CWB)		Cdh (Degradation heating)			1.0				
		COPd			5.71				
	Pdh	kW		3.6					
	PERd	%		228.3					
Tbiv (bivalent tempera- ture)	COPd			3.02					
	Pdh	kW		8.4					
	PERd	%		120.9					
	Tbiv	°C		4					
Average climate water outlet 35°C	General	Annual energy consumption	kWh	3,659		3,637			
		ηs (Seasonal space heating efficiency)	%	184		186			
		Prated at -10°C	kW			8.3			
		Qhe Annual energy consumption (GCV)	Gj			13			
		SCOP		4.69		4.71			
		Seasonal space heating eff. class			A+++				
	A Condition (-7°CDB- B/-8°CWB)	COPd			3.10				
		Pdh	kW		7.5				
		PERd	%		124.1				
	B Condition (2°CDB/1°CWB)	Cdh (Degradation heating)			1.0				
COPd				4.76					

## 2 Specifications

### 2 - 1 Specifications

2

Technical specifications					ELSH12P30E + ERRA08EV3	ELSH12P50E + ERRA08EV3	ELSH12P30E + ERRA10EV3	ELSH12P50E + ERRA10EV3	ELSH12P30E + ERRA12EV3	ELSH12P50E + ERRA12EV3	
Space heating Average climate water outlet 35°C	B Condition (2°CDB/ B/1°CWB)	Pdh	kW					4.4			
		PERd	%					190.4			
	C Condition (7°CDB/ B/6°CWB)	Cdh (Degradation heating)						1.0			
		COPd						6.14			
		Pdh	kW					4.3			
		PERd	%					245.8			
	D Condition (12°CDB/ B/11°CWB)	Cdh (Degradation heating)						1.0			
		COPd						7.84			
		Pdh	kW					6.6			
		PERd	%					313.4			
	Tol (tem- perature operating limit)	COPd				2.80			2.77		
		Pdh				6.9			8.1		
		PERd				112.2			110.8		
		TOL							-10		
	Tbiv (bivalent tempera- ture)	COPd				3.10			2.77		
		Pdh				7.5			8.1		
		PERd				124.1			110.8		
		Tbiv				-7			-10		
	Rated heat output sup- plementary capacity	Psup (at Tdesign -10°C)				1.4			0.0		
Cold climate water outlet 35°C	General	Annual energy consumption		kWh	5,554		5,401		5,387		
		ηs (Seasonal space heating efficiency)		%	157		161		162		
		Prated at -22°C		kW				9			
		Qhe Annual energy consumption (GCV)		Gj	20.0			19.4			
A Condition (-7°CDB/ B/-8°CWB)	COPd						3.36				
	Pdh						5.4				
	PERd						134.5				
B Condition (2°CDB/ B/1°CWB)	Cdh (Degradation heating)						1.0				
	COPd						5.21				
	Pdh						3.6				
C Condition (7°CDB/ B/6°CWB)	PERd						208.4				
	Cdh (Degradation heating)						1.0				
	COPd						6.29				
D Condition (12°CDB/ B/11°CWB)	Pdh						5.3				
	PERd						251.7				
	Cdh (Degradation heating)						1.0				
COPd						7.69					

## 2 Specifications

### 2 - 1 Specifications

Technical specifications				ELSH12P30E + ERRA08EV3	ELSH12P50E + ERRA08EV3	ELSH12P30E + ERRA10EV3	ELSH12P50E + ERRA10EV3	ELSH12P30E + ERRA12EV3	ELSH12P50E + ERRA12EV3
Space heating 	Cold climate water outlet 35°C	D Condition (12°CDB/ B/11°CWB)	Pdh	kW	6.6				
			PERd	%	307.6				
		Tol (tem- perature operating limit)	COPd		2.04		2.07		2.09
			Pdh	kW	4.9		5.9		6.4
		PERd	%	81.6		82.9		83.6	
		TOL	°C	-22					
		WTOL	°C	35					
		G Condition (-15°CDB/-)	COPd		2.60			2.56	
			Pdh	kW	6.0			7.0	
			PERd	%	103.8			102.6	
	Tbiv (bivalent tempera- ture)	COPd		2.86			2.56		
		Pdh	kW	6.5			7.0		
		PERd	%	114.4			102.6		
	Rated heat output sup- plementary capacity	Psup (at Tdesign -22°C)	Tbiv	°C	-12			-15	
			kW	4.1		3.1		2.6	
	Warm climate water outlet 35°C	General	Annual energy consumption	kWh	2,027				
			ηs (Seasonal space heating efficiency)	%	224				
			Prated at 2°C	kW	8.6				
			Qhe Annual energy consumption (GCV)	Gj	7				
		B Condition (2°CDB- B/1°CWB)	Cdh (Degradation heating)		1.0				
COPd				4.06					
Pdh			kW	6.8					
C Condition (7°CDB- B/6°CWB)		Cdh (Degradation heating)		1.0					
		COPd		5.65					
		Pdh	kW	5.5					
Tbiv (bivalent tempera- ture)	PERd	%	226.0						
	COPd		4.73						
	Pdh	kW	6.8						
D Condition (12°CDB- B/11°CWB)	PERd	%	189.2						
	Tbiv	°C	5						
	Cdh (Degradation heating)		1.0						
	COPd		7.52						
	Pdh	kW	6.1						
	PERd	%	300.8						

(1)Capacity according to standard EN14511 and valid for heated water range dT = 3~8°C at Ta 7°C |

(2)Condition: Ta DB/WB 7°C/6°C - LWC 35°C. (DT = 5°C) |

(3)Power input is total input of indoor and outdoor units, including the circulation pump; according to EN14511 |

(4)Test at Ta DB/WB 7°C/6°C. According to EN 16147. |

(5)DB/WB 7°C/6°C - LWC 35°C (dT=5°C) with pump at full speed |

Cooling: EW 12°C; LW 7°C; ambient conditions: 35°CDB |

Cooling: EW 23°C; LW 18°C; ambient conditions: 35°CDB

Technical specifications				ELSX12P30E + ERRA08EV3	ELSX12P50E + ERRA08EV3	ELSX12P30E + ERRA10EV3	ELSX12P50E + ERRA10EV3	ELSX12P30E + ERRA12EV3	ELSX12P50E + ERRA12EV3
Heating capacity	Min.		kW	3.45 (1)					
	Nom.		kW	6.17 (2)					
	Max.		kW	7.95 (1)		9.25 (1)		9.97 (1)	
Cooling capacity	Nom.		kW	6.81 (3) / 6.47 (4)		7.97 (3) / 6.47 (4)		8.62 (3) / 6.47 (4)	
Power input	Heating	Min.	kW	0.72 (5)					
		Nom.	kW	1.25 (2)					
		Max.	kW	1.69 (5)		2.04 (5)		2.28 (5)	
	Cooling	Nom.	kW	2.15 (3) / 1.16 (4)		2.66 (3) / 1.16 (4)		2.96 (3) / 1.16 (4)	
		Domestic hot water from 10°C to 50°C	Nom.	kWh	3.57 (6)	4.82 (6)	3.57 (6)	4.82 (6)	3.57 (6)
Heat up time from 10°C to 50°C			hr	2h29min	3h45min	2h29min	3h45min	2h29min	3h45min
COP				4.92 (2)					
EER				3.17 (3) / 5.56 (4)		3.00 (3) / 5.56 (4)		2.91 (3) / 5.56 (4)	
Pump	Type			Grundfos UPM4L K 20-75 CHBL 3 RT					
	Nominal ESP Heating unit		kPa	55.4 (7)					
Water side Heat exchanger	Water flow rate	Heating	Nom.						18.3

## 2 Specifications

### 2 - 1 Specifications

2

Technical specifications				ELSX12P30E + ERRA08EV3	ELSX12P50E + ERRA08EV3	ELSX12P30E + ERRA10EV3	ELSX12P50E + ERRA10EV3	ELSX12P30E + ERRA12EV3	ELSX12P50E + ERRA12EV3		
General	Supplier/ Manufacturer details	Name and address	Daikin Europe N.V. - Zandvoordestraat 300, 8400 Oostende, Belgium								
	Manufacturer details	Name or trademark	Daikin Europe N.V.								
	Product description	Air-to-water heat pump		Yes							
		Brine-to-water heat pump		No							
		Heat pump combination heater		Yes							
		Low-temperature heat pump		No							
		Supplementary heater integrated		No							
	LW(A) Sound power level (according to EN14825)	Indoor	dB(A)	44.7							
		Outdoor	dB(A)	56.0							
	Sound condition Ecodesign and energy label				Sound power in heating mode, measured according to the EN12102 under conditions of the EN14825						
Space heating general	Air to water unit	Rated airflow (outdoor)	m <sup>3</sup> /h	3,542							
	Other	Capacity control		Inverter							
		Pck (Crankcase heater mode)	kW	0.000							
		Poff (Off mode)	kW	0.021							
		Psb (Standby mode)	kW	0.021							
Pto (Thermostat off)	kW	0.024									
Domestic hot water heating	General	Declared load profile		L	XL	L	XL	L	XL		
	Average climate	AEC (Annual electricity consumption)	kWh	885	1,273	885	1,273	885	1,273		
		COPdhw		2.75	3.19	2.75	3.19	2.75	3.19		
		Heat up time		2h 29min	3h 28min	2h 29min	3h 28min	2h 29min	3h 28min		
Domestic hot water heating	Average climate	η <sub>wh</sub> (water heating efficiency)	%	116	132	116	132	116	132		
		Qelec (Daily electricity consumption)	kWh	4.240	5.980	4.240	5.980	4.240	5.980		
		Reference hot water temperature	°C	47.2	44.7	47.2	44.7	47.2	44.7		
		Stand-by power input	W	38.1	32.7	38.1	32.7	38.1	32.7		
	Water heating energy efficiency class			A+							
	Cold climate	AEC (Annual electricity consumption)	kWh	1,183	1,503	1,183	1,503	1,183	1,503		
		COPdhw		2.07	2.71	2.07	2.71	2.07	2.71		
		Heat up time		2h 23min	3h 37 min	2h 23min	3h 37 min	2h 23min	3h 37 min		
		η <sub>wh</sub> (water heating efficiency)	%	87	112	87	112	87	112		
		Qelec (Daily electricity consumption)	kWh	5.640	7.050	5.640	7.050	5.640	7.050		
Reference hot water temperature		°C	46.3	44.7	46.3	44.7	46.3	44.7			
Warm climate	Stand-by power input	W	46.4	36.5	46.4	36.5	46.4	36.5			
	AEC (Annual electricity consumption)	kWh	782	1,051	782	1,051	782	1,051			
	COPdhw		3.10	3.85	3.10	3.85	3.10	3.85			
	Heat up time		2h 18min	3h 17min	2h 18min	3h 17min	2h 18min	3h 17min			
	η <sub>wh</sub> (water heating efficiency)	%	131	159	131	159	131	159			
	Qelec (Daily electricity consumption)	kWh	3.760	4.960	3.760	4.960	3.760	4.960			
Space heating	Average climate water outlet 55°C	General	Annual energy consumption	kWh	7,664		7,645		7,433		
			η <sub>s</sub> (Seasonal space heating efficiency)	%	132				136		
		Prated at -10°C	kW			12.5					
		Q <sub>he</sub> Annual energy consumption (GCV)	Gj			28		27			
		SCOP		3.37		3.38		3.47			
		Seasonal space heating eff. class			A++						
		A Condition (-7°CDB/-8°CWB)	Cdh (Degradation heating)		1.0						
			COPd		2.26						
		B Condition (2°CDB/1°CWB)	Pdh	kW	7.6						
			PERd	%	90.4						
		B Condition (2°CDB/1°CWB)	Cdh (Degradation heating)		1.0						
			COPd		3.39						
		B Condition (2°CDB/1°CWB)	Pdh	kW	6.8						
			PERd	%	135.6						
C Condition (7°CDB/6°CWB)	Cdh (Degradation heating)		1.0								
	COPd		4.90								
C Condition (7°CDB/6°CWB)	Pdh	kW	4.5								
	PERd	%	196.0								

## 2 Specifications

### 2 - 1 Specifications

Technical specifications				ELSX12P30E + ERRA08EV3	ELSX12P50E + ERRA08EV3	ELSX12P30E + ERRA10EV3	ELSX12P50E + ERRA10EV3	ELSX12P30E + ERRA12EV3	ELSX12P50E + ERRA12EV3		
Space heating 	Average climate water outlet 55°C	D Condition (12°CDB/11°CWB)	Cdh (Degradation heating)	1.0							
			COPd	6.02							
			Pdh kW	5.2							
			PERd %	240.8							
		Tol (temperature operating limit)	COPd	1.97			2.00				
				6.9			8.2				
			Pdh kW	78.8			80.0				
				-10			-10				
			TOL °C	55			55				
				WTOL °C			55				
	Rated heat output supplementary capacity	Psup (at Tdesign -10°C) kW			5.6			4.3			
		Tbiv (bivalent temperature)	COPd	2.81			2.41				
	8.5			10.0							
	Pdh kW		112.4			96.4					
			-2			-5					
	Cold climate water outlet 55°C	General	Annual energy consumption kWh	7,257			7,127			7,100	
			ηs (Seasonal space heating efficiency) %	119			122				
			Prated at -22°C kW	9.0							
			Qhe Annual energy consumption (GCV) GJ	26							
		A Condition (-7°CDB/-8°CWB)	Cdh (Degradation heating)	COPd	1.0						
COPd				2.52							
Pdh kW				5.2							
PERd %				100.6							
B Condition (2°CDB/1°CWB)		Cdh (Degradation heating)	COPd	1.0							
			COPd	3.77							
	Pdh kW		3.3								
C Condition (7°CDB/6°CWB)	Cdh (Degradation heating)	COPd	1.0								
		COPd	4.81								
		Pdh kW	3.4								
D Condition (12°CDB/11°CWB)	Cdh (Degradation heating)	COPd	1.0								
		COPd	4.81								
		Pdh kW	3.4								
Tol (temperature operating limit)	COPd	1.43			1.49			1.54			
		4.9			6.1			7.2			
		57.4			59.7			61.7			
TOL °C	-22			-22			-22				

## 2 Specifications

### 2 - 1 Specifications

2

Technical specifications				ELSX12P30E + ERRA08EV3	ELSX12P50E + ERRA08EV3	ELSX12P30E + ERRA10EV3	ELSX12P50E + ERRA10EV3	ELSX12P30E + ERRA12EV3	ELSX12P50E + ERRA12EV3		
Space heating	Cold climate water outlet 55°C	Tol (tem- perature operating limit)	WTOL °C	55							
		G Condition (-15°CDB/-)	COPd		1.93				1.96		
			Pdh	kW	6.0				7.2		
			PERd	%	77.2				78.4		
		Tbiv (bivalent tempera- ture)	COPd		2.17				1.96		
			Pdh	kW	6.6				7.2		
			PERd	%	86.9				78.4		
		Rated heat output sup- plementary capacity	Psup (at Tdesign -22°C)	kW	4.1		2.9		-15		1.8
		Warm climate water outlet 55°C	General	Annual energy consumption	kWh	2,946					
ηs (Seasonal space heating efficiency)	%			171							
Prated at 2°C	kW			9.6							
Qhe Annual energy consumption (GCV)	Gj			11							
B Condition (2°CDB- B/1°CWB)	Cdh (Degradation heating)			1.0							
	COPd			2.57							
	Pdh		kW	8.0							
	PERd		%	102.6							
C Condition (7°CDB- B/6°CWB)	Cdh (Degradation heating)			1.0							
	COPd			3.65							
	Pdh		kW	6.7							
	PERd		%	146.2							
D Condition (12°CDB- B/11°CWB)	Cdh (Degradation heating)			1.0							
	COPd			5.71							
	Pdh		kW	3.6							
	PERd		%	228.3							
Tbiv (bivalent tempera- ture)	COPd			3.02							
	Pdh	kW	8.4								
	PERd	%	120.9								
	Tbiv	°C	4								
Average climate water outlet 35°C	General	Annual energy consumption	kWh	3,582				3,560			
		ηs (Seasonal space heating efficiency)	%	188				190			
		Prated at -10°C	kW	8.3							
		Qhe Annual energy consumption (GCV)	Gj	13							
		SCOP		4.79				4.82			
	Seasonal space heating eff. class			A+++							
	A Condition (-7°CDB/-8°CWB)	COPd		3.10							
Pdh		kW	7.5								

## 2 Specifications



### 2 - 1 Specifications

Technical specifications				ELSX12P30E + ERRA08EV3	ELSX12P50E + ERRA08EV3	ELSX12P30E + ERRA10EV3	ELSX12P50E + ERRA10EV3	ELSX12P30E + ERRA12EV3	ELSX12P50E + ERRA12EV3	
Space heating Cold climate water outlet 35°C	Average climate	A Condition (-7°C-D- B/-8°CWB)	PERd %				124.1			
	35°C	B Condition (2°C-D- B/1°CWB)	Cdh (Degradation heating)				1.0			
			COPd				4.76			
			Pdh kW				4.4			
			PERd %				190.4			
	C Condition (7°C-D- B/6°CWB)	Cdh (Degradation heating)	COPd				1.0			
			Pdh kW				6.14			
			PERd %				4.3			
							245.8			
	D Condition (12°C-D- B/11°CWB)	Cdh (Degradation heating)	COPd				1.0			
			Pdh kW				7.84			
			PERd %				6.6			
							313.4			
	Tol (tem- perature operating limit)	COPd	Pdh kW		2.80			2.77		
			PERd %		6.9			8.1		
			TOL °C		112.2			110.8		
			WTOL °C					-10		
	Tbiv (bivalent tempera- ture)	COPd	Pdh kW		3.10			2.77		
			PERd %		7.5			8.1		
			Tbiv °C		124.1			110.8		
					-7			-10		
	Rated heat output sup- plementary capacity	Psup (at Tdesign -10°C)			1.4			0.0		
	Cold climate water outlet 35°C	General	Annual energy consumption	kWh	5,507			5,355		5,340
			ηs (Seasonal space heating efficiency)	%	158			163		
			Prated at -22°C	kW				9		
			Qhe Annual energy consumption (GCV)	Gj	19.8			19.3		19.2
		A Condition (-7°C-D- B/-8°CWB)	COPd	Pdh kW				3.36		
				PERd %				5.4		
								134.5		
B Condition (2°C-D- B/1°CWB)		Cdh (Degradation heating)	COPd				1.0			
			Pdh kW				5.21			
			PERd %				3.6			
C Condition (7°C-D- B/6°CWB)	Cdh (Degradation heating)	COPd				1.0				
		Pdh kW				6.29				
		PERd %				208.4				
	COPd	Pdh kW				5.3				

# 2 Specifications

## 2 - 1 Specifications

2



Technical specifications				ELSX12P30E + ERRA08EV3	ELSX12P50E + ERRA08EV3	ELSX12P30E + ERRA10EV3	ELSX12P50E + ERRA10EV3	ELSX12P30E + ERRA12EV3	ELSX12P50E + ERRA12EV3	
Space heating 	Cold climate water outlet 35°C	C Condition (7°CDB- B/6°CWB)	PERd	%	251.7					
			D Condition (12°CDB- B/11°CWB)		Cdh (Degradation heating)	1.0				
				COPd	7.69					
				Pdh	6.6					
				PERd	307.6					
		Tol (tem- perature operating limit)	COPd		2.04		2.07		2.09	
			Pdh		4.9		5.9		6.4	
			PERd		81.6		82.9		83.6	
			TOL		°C		-22			
		WTOL		°C		35				
	G Condition (-15°CDB/-)	COPd		2.60			2.56			
		Pdh		6.0			7.0			
		PERd		103.8			102.6			
	Tbiv (bivalent tempera- ture)	COPd		2.86			2.56			
		Pdh		6.5			7.0			
		PERd		114.4			102.6			
	Rated heat output sup- plementary capacity	Tbiv		°C	-12					
		Psup (at Tdesign -22°C)		kW	4.1		3.1		2.6	
	Warm climate water outlet 35°C	General	Annual energy consumption		kWh					1,934
			ηs (Seasonal space heating efficiency)		%					235
Prated at 2°C			kW					8.6		
Qhe Annual energy consumption (GCV)			Gj					7		
B Condition (2°CDB- B/1°CWB)		Cdh (Degradation heating)		1.0						
		COPd		4.06						
		Pdh		6.8						
		PERd		162.4						
C Condition (7°CDB- B/6°CWB)		Cdh (Degradation heating)		1.0						
		COPd		5.65						
	Pdh		5.5							
	PERd		226.0							
Tbiv (bivalent tempera- ture)	COPd		4.73							
	Pdh		6.8							
	PERd		189.2							
	Tbiv		°C					5		
D Condition (12°CDB- B/11°CWB)	Cdh (Degradation heating)		1.0							
	COPd		7.52							
	Pdh		6.1							
Space heating 	Warm climate water outlet 35°C	D Condition (12°CDB- B/11°CWB)	PERd	%	300.8					

(1)Capacity according to standard EN14511 and valid for heated water range dT = 3~8°C at Ta 7°C |  
 (2)Condition: Ta DB/WB 7°C/6°C - LWC 35°C. (DT = 5°C) |  
 (3)Cooling: EW 12°C; LW 7°C; ambient conditions: 35°CDB |  
 (4)Cooling: EW 23°C; LW 18°C; ambient conditions: 35°CDB |  
 (5)Power input is total input of indoor and outdoor units, including the circulation pump; according to EN14511 |  
 (6)Test at Ta DB/WB 7°C/6°C. According to EN 16147. |  
 (7)DB/WB 7°C/6°C - LWC 35°C (dT=5°C) with pump at full speed

Technical specifications				ELSHB12P30E + ERRA08EV3	ELSHB12P50E + ERRA08EV3	ELSHB12P30E + ERRA10EV3	ELSHB12P50E + ERRA10EV3	ELSHB12P30E + ERRA12EV3	ELSHB12P50E + ERRA12EV3	
Heating capacity	Min.	kW		3.45 (1)						
	Nom.	kW		6.17 (2)						
	Max.	kW		7.95 (1)		9.25 (1)		9.97 (1)		
Power input	Heating	Min.	kW		0.72 (3)					
		Nom.	kW		1.25 (2)					
		Max.	kW		1.69 (3)		2.04 (3)		2.28 (3)	
	Domestic hot water from 10°C to 50°C	Nom.	kWh		3.57 (4)	4.82 (4)	3.57 (4)	4.82 (4)	3.57 (4)	4.82 (4)
Heat up time from 10°C to 50°C			hr	2h29min	3h45min	2h29min	3h45min	2h29min	3h45min	
COP				4.92 (2)						

## 2 Specifications

### 2 - 1 Specifications

Technical specifications				ELSHB12P30E + ERRA08EV3	ELSHB12P50E + ERRA08EV3	ELSHB12P30E + ERRA10EV3	ELSHB12P50E + ERRA10EV3	ELSHB12P30E + ERRA12EV3	ELSHB12P50E + ERRA12EV3	
Pump	Type	Grundfos UPM4L K 20-75 CHBL 3 RT								
	Nominal ESP Heating unit	kPa	55.4 (5)							
Water side Heat exchanger	Water flow rate	Heating Nom.	l/min	18.3						
General	Supplier/Manufacturer details	Name and address	Daikin Europe N.V. - Zandvoordestraat 300, 8400 Oostende, Belgium							
		Name or trademark	Daikin Europe N.V.							
Product description	Air-to-water heat pump	Yes								
	Brine-to-water heat pump	No								
	Heat pump combination heater	Yes								
	Low-temperature heat pump	No								
	Supplementary heater integrated	No								
	Water-to-water heat pump	No								
LW(A) Sound power level (according to EN14825)	Indoor	dB(A)	44.7							
LW(A) Sound power level (according to EN14825)	Outdoor	dB(A)	56.0							
Sound condition Ecodesign and energy label				Sound power in heating mode, measured according to the EN12102 under conditions of the EN14825						
Space heating general	Air to water unit	Rated airflow (outdoor)	m <sup>3</sup> /h	3,542						
	Other	Capacity control	Inverter							
		Pck (Crankcase heater mode)	kW	0.000						
		Poff (Off mode)	kW	0.021						
		Psb (Standby mode)	kW	0.021						
		Pto (Thermostat off)	kW	0.024						
Domestic hot water heating 	General	Declared load profile	L	XL	L	XL	L	XL		
	Average climate	AEC (Annual electricity consumption)	kWh	885	1,273	885	1,273	885	1,273	
		COPdhw		2.75	3.19	2.75	3.19	2.75	3.19	
		Heat up time		2h 29min	3h 28min	2h 29min	3h 28min	2h 29min	3h 28min	
		η <sub>wh</sub> (water heating efficiency)	%	116	132	116	132	116	132	
		Qelec (Daily electricity consumption)	kWh	4.240	5.980	4.240	5.980	4.240	5.980	
		Reference hot water temperature	°C	47.2	44.7	47.2	44.7	47.2	44.7	
		Stand-by power input	W	38.1	32.7	38.1	32.7	38.1	32.7	
Domestic hot water heating 	Average climate	Water heating energy efficiency class	A+							
	Cold climate	AEC (Annual electricity consumption)	kWh	1,183	1,503	1,183	1,503	1,183	1,503	
		COPdhw		2.07	2.71	2.07	2.71	2.07	2.71	
		Heat up time		2h 23min	3h 37 min	2h 23min	3h 37 min	2h 23min	3h 37 min	
		η <sub>wh</sub> (water heating efficiency)	%	87	112	87	112	87	112	
		Qelec (Daily electricity consumption)	kWh	5.640	7.050	5.640	7.050	5.640	7.050	
		Reference hot water temperature	°C	46.3	44.7	46.3	44.7	46.3	44.7	
		Stand-by power input	W	46.4	36.5	46.4	36.5	46.4	36.5	
	Warm climate	AEC (Annual electricity consumption)	kWh	782	1,051	782	1,051	782	1,051	
		COPdhw		3.10	3.85	3.10	3.85	3.10	3.85	
		Heat up time		2h 18min	3h 17min	2h 18min	3h 17min	2h 18min	3h 17min	
		η <sub>wh</sub> (water heating efficiency)	%	131	159	131	159	131	159	
		Qelec (Daily electricity consumption)	kWh	3.760	4.960	3.760	4.960	3.760	4.960	
		Reference hot water temperature	°C	47.2	44.7	47.2	44.7	47.2	44.7	
		Stand-by power input	W	35.8	31.2	35.8	31.2	35.8	31.2	

## 2 Specifications

### 2 - 1 Specifications

Technical specifications				ELSHB12P30E + ERRA08EV3	ELSHB12P50E + ERRA08EV3	ELSHB12P30E + ERRA10EV3	ELSHB12P50E + ERRA10EV3	ELSHB12P30E + ERRA12EV3	ELSHB12P50E + ERRA12EV3		
Space heating	Average climate water outlet 55°C	General	Annual energy consumption	kWh	7,742		7,723		7,510		
			ηs (Seasonal space heating efficiency)	%	130		131		135		
			Prated at -10°C	kW			12.5				
			Qhe Annual energy consumption (GCV)	Gj		28			27		
			SCOP			3.34			3.44		
			Seasonal space heating eff. class				A++				
			A Condition (-7°CDB)	Cdh (Degradation heating)				1.0			
				COPd				2.26			
				Pdh	kW			7.6			
				PERd	%			90.4			
			B Condition (2°CDB)	Cdh (Degradation heating)				1.0			
				COPd				3.39			
				Pdh	kW			6.8			
				PERd	%			135.6			
			C Condition (7°CDB)	Cdh (Degradation heating)				1.0			
				COPd				4.90			
				Pdh	kW			4.5			
				PERd	%			196.0			
			D Condition (12°CDB)	Cdh (Degradation heating)				1.0			
				COPd				6.02			
	Pdh	kW			5.2						
	PERd	%			240.8						
Space heating	Average climate water outlet 55°C	General	Tol (temperature operating limit)	COPd	1.97			2.00			
				Pdh	kW	6.9			8.2		
				PERd	%	78.8			80.0		
				TOL	°C				-10		
				WTOL	°C				55		
			Rated heat output supplementary capacity	Psup (at Tdesign -10°C)	kW	5.6			4.3		
			Tbiv (bivalent temperature)	COPd			2.81			2.41	
				Pdh	kW		8.5			10.0	
				PERd	%		112.4			96.4	
				Tbiv	°C		-2			-5	
			Cold climate water outlet 55°C	General	Annual energy consumption	kWh	7,303		7,173		7,146
					ηs (Seasonal space heating efficiency)	%	118			121	
					Prated at -22°C	kW			9.0		
					Qhe Annual energy consumption (GCV)	Gj			26		
					A Condition (-7°CDB)	Cdh (Degradation heating)				1.0	
						COPd				2.52	
						Pdh	kW			5.2	
						PERd	%			100.6	
					B Condition (2°CDB)	Cdh (Degradation heating)				1.0	
						COPd				3.77	
	Pdh	kW					3.3				
	PERd	%					151.0				
C Condition (7°CDB)	Cdh (Degradation heating)						1.0				
	COPd						4.81				
	Pdh	kW					3.4				
	PERd	%					192.2				
D Condition (12°CDB)	COPd						6.36				
	Pdh	kW					4.2				
	PERd	%					254.2				
Tol (temperature operating limit)	COPd				1.43				1.54		
	Pdh	kW	4.9				7.2				
	PERd	%	57.4				61.7				
	TOL	°C					-22				
	WTOL	°C					55				
G Condition (-15°CDB/-)	COPd		1.93				1.96				
	Pdh	kW	6.0				7.2				

## 2 Specifications

### 2 - 1 Specifications

Technical specifications				ELSHB12P30E + ERRA08EV3	ELSHB12P50E + ERRA08EV3	ELSHB12P30E + ERRA10EV3	ELSHB12P50E + ERRA10EV3	ELSHB12P30E + ERRA12EV3	ELSHB12P50E + ERRA12EV3	
Space heating 	Cold climate water outlet 55°C	G Condition (-15°CDB/-)	PERd	%	77.2			78.4		
			Tbiv	COPd		2.17		1.96		
		(bivalent tempera- ture)	Pdh	kW	6.6		7.2			
			PERd	%	86.9		78.4			
			Tbiv	°C	-12		-15			
	Rated heat output sup- plementary capacity	Psup (at Tdesign -22°C)	kW	4.1		2.9		1.8		
	Warm climate water outlet 55°C	General	Annual energy consumption	kWh			3,039			
			ηs (Seasonal space heating efficiency)	%			166			
			Prated at 2°C	kW			9.6			
			Qhe Annual energy consumption (GCV)	Gj			11			
			B Condition (2°CDB- B/1°CWB)	Cdh (Degradation heating)				1.0		
		COPd					2.57			
		Pdh		kW			8.0			
		C Condition (7°CDB- B/6°CWB)	Cdh (Degradation heating)				1.0			
			COPd				3.65			
Pdh			kW			6.7				
D Condition (12°CDB- B/11°CWB)		Cdh (Degradation heating)				1.0				
		COPd				5.71				
		Pdh	kW			3.6				
Tbiv (bivalent tempera- ture)		PERd	%			228.3				
		Tbiv	°C			4				
	COPd				3.02					
Average climate water outlet 35°C	General	Pdh	kW			8.4				
		PERd	%			120.9				
		Annual energy consumption	kWh	3,659			3,637			
		ηs (Seasonal space heating efficiency)	%	184			186			
		Prated at -10°C	kW			8.3				
	Qhe Annual energy consumption (GCV)	Gj			13					
	SCOP		4.69			4.71				
	Seasonal space heating eff. class					A+++				
A Condition (-7°CDB- B/-8°CWB)	COPd				3.10					
	Pdh	kW			7.5					
	PERd	%			124.1					
B Condition (2°CDB/1°CWB)	Cdh (Degradation heating)				1.0					
	COPd				4.76					

## 2 Specifications

### 2 - 1 Specifications

2

Technical specifications					ELSHB12P30E + ERRA08EV3	ELSHB12P50E + ERRA08EV3	ELSHB12P30E + ERRA10EV3	ELSHB12P50E + ERRA10EV3	ELSHB12P30E + ERRA12EV3	ELSHB12P50E + ERRA12EV3	
Space heating Average climate water outlet 35°C	B Condition (2°CDB/1°CWB)	Pdh	kW							4.4	
		PERd	%							190.4	
	C Condition (7°CDB/6°CWB)	Cdh (Degradation heating)								1.0	
		COPd								6.14	
		Pdh	kW							4.3	
		PERd	%							245.8	
	D Condition (12°CDB/11°CWB)	Cdh (Degradation heating)								1.0	
		COPd								7.84	
		Pdh	kW							6.6	
		PERd	%							313.4	
	Tol (tem- perature operating limit)	COPd				2.80				2.77	
		Pdh				6.9				8.1	
		PERd				112.2				110.8	
		TOL								-10	
	Tbiv (bivalent tempera- ture)	COPd				3.10				2.77	
		Pdh				7.5				8.1	
		PERd				124.1				110.8	
		Tbiv				-7				-10	
	Rated heat output sup- plementary capacity	Psup (at Tdesign -10°C)				1.4				0.0	
Cold climate water outlet 35°C	General	Annual energy consumption			5,554			5,401		5,387	
		ηs (Seasonal space heating efficiency)			157			161		162	
		Prated at -22°C						9			
		Qhe Annual energy consumption (GCV)			20.0			19.4			
A Condition (-7°CDB/-8°CWB)	COPd								3.36		
	Pdh								5.4		
	PERd								134.5		
B Condition (2°CDB/1°CWB)	Cdh (Degradation heating)								1.0		
	COPd								5.21		
	Pdh								3.6		
C Condition (7°CDB/6°CWB)	PERd								208.4		
	Cdh (Degradation heating)								1.0		
	COPd								6.29		
D Condition (12°CDB/11°CWB)	Pdh								5.3		
	PERd								251.7		
	Cdh (Degradation heating)								1.0		
COPd								7.69			

## 2 Specifications

### 2 - 1 Specifications

Technical specifications				ELSHB12P30E + ERRA08EV3	ELSHB12P50E + ERRA08EV3	ELSHB12P30E + ERRA10EV3	ELSHB12P50E + ERRA10EV3	ELSHB12P30E + ERRA12EV3	ELSHB12P50E + ERRA12EV3
Space heating 	Cold climate water outlet 35°C	D Condition (12°CDB/ B/11°CWB)	Pdh	kW	6.6				
			PERd	%	307.6				
		Tol (tem- perature operating limit)	COPd		2.04		2.07		2.09
			Pdh	kW	4.9		5.9		6.4
		PERd	%	81.6		82.9		83.6	
		TOL	°C	-22					
		WTOL	°C	35					
		G Condition (-15°CDB/-)	COPd		2.60			2.56	
			Pdh	kW	6.0			7.0	
			PERd	%	103.8			102.6	
	Tbiv (bivalent tempera- ture)	COPd		2.86			2.56		
		Pdh	kW	6.5			7.0		
		PERd	%	114.4			102.6		
	Rated heat output sup- plementary capacity	Psup (at Tdesign -22°C)	Tbiv	°C	-12			-15	
			kW	4.1		3.1		2.6	
	Warm climate water outlet 35°C	General	Annual energy consumption	kWh	2,027				
			ηs (Seasonal space heating efficiency)	%	224				
			Prated at 2°C	kW	8.6				
			Qhe Annual energy consumption (GCV)	Gj	7				
		B Condition (2°CDB- B/1°CWB)	Cdh (Degradation heating)			1.0			
COPd				4.06					
Pdh			kW	6.8					
PERd			%	162.4					
C Condition (7°CDB- B/6°CWB)		Cdh (Degradation heating)			1.0				
		COPd		5.65					
	Pdh	kW	5.5						
	PERd	%	226.0						
Tbiv (bivalent tempera- ture)	COPd		4.73						
	Pdh	kW	6.8						
	PERd	%	189.2						
	Tbiv	°C	5						
D Condition (12°CDB- B/11°CWB)	Cdh (Degradation heating)			1.0					
	COPd		7.52						
	Pdh	kW	6.1						
	PERd	%	300.8						

(1)Capacity according to standard EN14511 and valid for heated water range dT = 3~8°C at Ta 7°C |

(2)Condition: Ta DB/WB 7°C/6°C - LWC 35°C. (DT = 5°C) |

(3)Power input is total input of indoor and outdoor units, including the circulation pump; according to EN14511 |

(4)Test at Ta DB/WB 7°C/6°C. According to EN 16147. |

(5)DB/WB 7°C/6°C - LWC 35°C (dT=5°C) with pump at full speed |

Cooling: EW 12°C; LW 7°C; ambient conditions: 35°CDB |

Cooling: EW 23°C; LW 18°C; ambient conditions: 35°CDB

Technical specifications				ELSX12P30E + ERRA08EV3	ELSX12P50E + ERRA08EV3	ELSX12P30E + ERRA10EV3	ELSX12P50E + ERRA10EV3	ELSX12P30E + ERRA12EV3	ELSX12P50E + ERRA12EV3
Heating capacity	Min.		kW	3.45 (1)					
	Nom.		kW	6.17 (2)					
	Max.		kW	7.95 (1)		9.25 (1)		9.97 (1)	
Cooling capacity	Nom.		kW	6.81 (3) / 6.47 (4)		7.97 (3) / 6.47 (4)		8.62 (3) / 6.47 (4)	
Power input	Heating	Min.	kW	0.72 (5)					
		Nom.	kW	1.25 (2)					
		Max.	kW	1.69 (5)		2.04 (5)		2.28 (5)	
	Cooling	Nom.	kW	2.15 (3) / 1.16 (4)		2.66 (3) / 1.16 (4)		2.96 (3) / 1.16 (4)	
		Domestic hot water from 10°C to 50°C	Nom.	kWh	3.57 (6)	4.82 (6)	3.57 (6)	4.82 (6)	3.57 (6)
Heat up time from 10°C to 50°C			hr	2h29min	3h45min	2h29min	3h45min	2h29min	3h45min
COP				4.92 (2)					
EER				3.17 (3) / 5.56 (4)		3.00 (3) / 5.56 (4)		2.91 (3) / 5.56 (4)	
Pump	Type			Grundfos UPM4L K 20-75 CHBL 3 RT					
	Nominal ESP Heating unit		kPa	55.4 (7)					
Water side Heat exchanger	Water flow rate	Heating	Nom.	l/min					
				18.3					

## 2 Specifications

### 2 - 1 Specifications

2

Technical specifications				ELSXB12P30E + ERRA08EV3	ELSXB12P50E + ERRA08EV3	ELSXB12P30E + ERRA10EV3	ELSXB12P50E + ERRA10EV3	ELSXB12P30E + ERRA12EV3	ELSXB12P50E + ERRA12EV3			
General	Supplier/ Manufacturer details	Name and address	Daikin Europe N.V. - Zandvoordestraat 300, 8400 Oostende, Belgium									
	Manufacturer details	Name or trademark	Daikin Europe N.V.									
	Product description	Air-to-water heat pump		Yes								
		Brine-to-water heat pump		No								
		Heat pump combination heater		Yes								
		Low-temperature heat pump		No								
		Supplementary heater integrated		No								
		Water-to-water heat pump		No								
	LW(A) Sound power level (according to EN14825)	Indoor	dB(A)	44.7								
	LW(A) Sound power level (according to EN14825)	Outdoor	dB(A)	56.0								
Sound condition Ecodesign and energy label				Sound power in heating mode, measured according to the EN12102 under conditions of the EN14825								
Space heating general	Air to water unit	Rated airflow (outdoor)	m <sup>3</sup> /h	3,542								
	Other	Capacity control		Inverter								
		Pck (Crankcase heater mode)	kW	0.000								
		Poff (Off mode)	kW	0.021								
		Psb (Standby mode)	kW	0.021								
		Pto (Thermostat off)	kW	0.024								
Domestic hot water heating	General	Declared load profile		L	XL	L	XL	L	XL			
	Average climate	AEC (Annual electricity consumption)	kWh	885	1,273	885	1,273	885	1,273			
		COPdhw		2.75	3.19	2.75	3.19	2.75	3.19			
		Heat up time		2h 29min	3h 28min	2h 29min	3h 28min	2h 29min	3h 28min			
Domestic hot water heating	Average climate	η <sub>wh</sub> (water heating efficiency)	%	116	132	116	132	116	132			
		Qelec (Daily electricity consumption)	kWh	4.240	5.980	4.240	5.980	4.240	5.980			
		Reference hot water temperature	°C	47.2	44.7	47.2	44.7	47.2	44.7			
		Stand-by power input	W	38.1	32.7	38.1	32.7	38.1	32.7			
Water heating energy efficiency class				A+								
Cold climate	AEC (Annual electricity consumption)	kWh	1,183	1,503	1,183	1,503	1,183	1,503				
		COPdhw		2.07	2.71	2.07	2.71	2.07	2.71			
	Heat up time		2h 23min	3h 37 min	2h 23min	3h 37 min	2h 23min	3h 37 min				
		η <sub>wh</sub> (water heating efficiency)	%	87	112	87	112	87	112			
	Qelec (Daily electricity consumption)	kWh	5.640	7.050	5.640	7.050	5.640	7.050				
		Reference hot water temperature	°C	46.3	44.7	46.3	44.7	46.3	44.7			
	Stand-by power input	W	46.4	36.5	46.4	36.5	46.4	36.5				
						A+						
	Warm climate	AEC (Annual electricity consumption)	kWh	782	1,051	782	1,051	782	1,051			
			COPdhw		3.10	3.85	3.10	3.85	3.10	3.85		
Heat up time			2h 18min	3h 17min	2h 18min	3h 17min	2h 18min	3h 17min				
		η <sub>wh</sub> (water heating efficiency)	%	131	159	131	159	131	159			
Qelec (Daily electricity consumption)		kWh	3.760	4.960	3.760	4.960	3.760	4.960				
		Reference hot water temperature	°C	47.2	44.7	47.2	44.7	47.2	44.7			
Stand-by power input		W	35.8	31.2	35.8	31.2	35.8	31.2				
						A+						
Space heating	Average climate water outlet 55°C	General	Annual energy consumption	kWh	7,664		7,645		7,433			
			η <sub>s</sub> (Seasonal space heating efficiency)	%	132				136			
		Prated at -10°C	Qhe Annual energy consumption (GCV)	Gj	28				27			
			SCOP		3.37		3.38		3.47			
		Seasonal space heating eff. class				A++						
		A Condition (-7°CDB)	Cdh (Degradation heating)	COPd				1.0				
								2.26				
		B/-8°CWB)	Pdh	kW			7.6					
				PERd	%			90.4				
		B Condition (2°CDB)	Cdh (Degradation heating)	COPd				1.0				
								3.39				
		B/1°CWB)	Pdh	kW			6.8					
				PERd	%			135.6				
		C Condition (7°CDB)	Cdh (Degradation heating)	COPd				1.0				
								4.90				
		B/6°CWB)	Pdh	kW			4.5					
				PERd	%			196.0				

## 2 Specifications

### 2 - 1 Specifications

Technical specifications				ELSXB12P30E + ERRA08EV3	ELSXB12P50E + ERRA08EV3	ELSXB12P30E + ERRA10EV3	ELSXB12P50E + ERRA10EV3	ELSXB12P30E + ERRA12EV3	ELSXB12P50E + ERRA12EV3		
Space heating Average climate water outlet 55°C Cold climate water outlet 55°C	D Condition (12°CDB/11°CWB)	Cdh (Degradation heating)		1.0							
		COPd		6.02							
		Pd <sub>h</sub> kW		5.2							
		PER <sub>d</sub> %		240.8							
		Tol (temperature operating limit)		COPd		1.97		2.00			
				Pd <sub>h</sub> kW		6.9		8.2			
				PER <sub>d</sub> %		78.8		80.0			
				TOL °C				-10			
				WTOL °C				55			
		Rated heat output supplementary capacity		P <sub>sup</sub> (at T <sub>design</sub> -10°C) kW		5.6		4.3			
		Tbiv (bivalent temperature)		COPd		2.81				2.41	
				Pd <sub>h</sub> kW		8.5				10.0	
				PER <sub>d</sub> %		112.4				96.4	
				Tbiv °C		-2				-5	
		General		Annual energy consumption		7,257		7,127		7,100	
			η <sub>s</sub> (Seasonal space heating efficiency)		119		122				
			Prated at -22°C kW				9.0				
			Q <sub>he</sub> Annual energy consumption (GCV) GJ				26				
	A Condition (-7°CDB/-8°CWB)		Cdh (Degradation heating)		1.0						
			COPd		2.52						
			Pd <sub>h</sub> kW		5.2						
			PER <sub>d</sub> %		100.6						
	B Condition (2°CDB/1°CWB)		Cdh (Degradation heating)		1.0						
			COPd		3.77						
			Pd <sub>h</sub> kW		3.3						
			PER <sub>d</sub> %		151.0						
	C Condition (7°CDB/6°CWB)		Cdh (Degradation heating)		1.0						
		COPd		4.81							
		Pd <sub>h</sub> kW		3.4							
		PER <sub>d</sub> %		192.2							
D Condition (12°CDB/11°CWB)		COPd		6.36							
		Pd <sub>h</sub> kW		4.2							
		PER <sub>d</sub> %		254.2							
Tol (temperature operating limit)		COPd		1.43		1.49		1.54			
		Pd <sub>h</sub> kW		4.9		6.1		7.2			
		PER <sub>d</sub> %		57.4		59.7		61.7			
		TOL °C				-22					

## 2 Specifications

### 2 - 1 Specifications

Technical specifications				ELSXB12P30E + ERRA08EV3	ELSXB12P50E + ERRA08EV3	ELSXB12P30E + ERRA10EV3	ELSXB12P50E + ERRA10EV3	ELSXB12P30E + ERRA12EV3	ELSXB12P50E + ERRA12EV3		
Space heating 	Cold climate water outlet 55°C	Tol (tem- perature operating limit)	WTOL °C	55							
		G Condition (-15°CDB/-)	COPd		1.93		1.96				
			Pdh	kW	6.0		7.2				
			PERd	%	77.2		78.4				
		Tbiv (bivalent tempera- ture)	COPd		2.17		1.96				
			Pdh	kW	6.6		7.2				
			PERd	%	86.9		78.4				
		Rated heat output sup- plementary capacity	Tbiv	°C	-12		-15				
			Psup (at Tdesign -22°C)	kW	4.1		2.9		1.8		
Warm climate water outlet 55°C	General	Annual energy consumption	kWh	2,946							
		ηs (Seasonal space heating efficiency)	%	171							
		Prated at 2°C	kW	9.6							
		Qhe Annual energy consumption (GCV)	Gj	11							
	B Condition (2°CDB- B/1°CWB)	Cdh (Degradation heating)			1.0						
		COPd		2.57							
		Pdh	kW	8.0							
		PERd	%	102.6							
	C Condition (7°CDB- B/6°CWB)	Cdh (Degradation heating)			1.0						
		COPd		3.65							
		Pdh	kW	6.7							
		PERd	%	146.2							
	D Condition (12°CDB- B/11°CWB)	Cdh (Degradation heating)			1.0						
		COPd		5.71							
		Pdh	kW	3.6							
		PERd	%	228.3							
	Tbiv (bivalent tempera- ture)	COPd		3.02							
		Pdh	kW	8.4							
		PERd	%	120.9							
Tbiv		°C	4								
Average climate water outlet 35°C	General	Annual energy consumption	kWh	3,582		3,560					
		ηs (Seasonal space heating efficiency)	%	188		190					
		Prated at -10°C	kW	8.3							
		Qhe Annual energy consumption (GCV)	Gj	13							
		SCOP		4.79		4.82					
	Seasonal space heating eff. class			A+++							
	A Condition (-7°CDB/-8°CWB)	COPd		3.10							
Pdh		kW	7.5								

## 2 Specifications

### 2 - 1 Specifications

Technical specifications				ELSXB12P30E + ERRA08EV3	ELSXB12P50E + ERRA08EV3	ELSXB12P30E + ERRA10EV3	ELSXB12P50E + ERRA10EV3	ELSXB12P30E + ERRA12EV3	ELSXB12P50E + ERRA12EV3	
Space heating 	Average climate water outlet 35°C	A Condition (-7°C-D B/-8°CWB)	PERd %							124.1
		B Condition (2°C-D B/1°CWB)	Cdh (Degradation heating)							1.0
		COPd							4.76	
		Pdh kW							4.4	
		PERd %							190.4	
		C Condition (7°C-D B/6°CWB)	Cdh (Degradation heating)							1.0
		COPd							6.14	
		Pdh kW							4.3	
		PERd %							245.8	
		D Condition (12°C-D B/11°CWB)	Cdh (Degradation heating)							1.0
		COPd							7.84	
		Pdh kW							6.6	
		PERd %							313.4	
		Tol (temperature operating limit)	COPd	2.80				2.77		
			Pdh kW	6.9				8.1		
		TOL	PERd %	112.2				110.8		
			WTOL °C					-10		
		Tbiv (bivalent temperature)	COPd	3.10				2.77		
			Pdh kW	7.5				8.1		
		Tbiv	PERd %	124.1				110.8		
			Tbiv °C	-7				-10		
		Rated heat output supplementary capacity	Psup (at Tdesign -10°C)	1.4				0.0		
	Cold climate water outlet 35°C	General	Annual energy consumption	kWh	5,507		5,355		5,340	
			ηs (Seasonal space heating efficiency)	%	158				163	
Prated at -22°C			kW			9				
Qhe Annual energy consumption (GCV)			Gj	19.8		19.3		19.2		
A Condition (-7°C-D B/-8°CWB)		COPd							3.36	
		Pdh kW							5.4	
		PERd %							134.5	
B Condition (2°C-D B/1°CWB)		Cdh (Degradation heating)							1.0	
		COPd							5.21	
		Pdh kW							3.6	
C Condition (7°C-D B/6°CWB)	PERd %							208.4		
	Cdh (Degradation heating)							1.0		
	COPd							6.29		
	Pdh kW							5.3		

## 2 Specifications

### 2 - 1 Specifications

2

Technical specifications				ELSXB12P30E + ERRA08EV3	ELSXB12P50E + ERRA08EV3	ELSXB12P30E + ERRA10EV3	ELSXB12P50E + ERRA10EV3	ELSXB12P30E + ERRA12EV3	ELSXB12P50E + ERRA12EV3	
Space heating 	Cold climate water outlet 35°C	C Condition (7°CDB/ B/6°CWB)	PERd	%	251.7					
			D Condition (12°CDB/ B/11°CWB)	Cdh (Degradation heating)		1.0				
			COPd		7.69					
			Pdh	kW	6.6					
			PERd	%	307.6					
		Tol (tem- perature operating limit)		COPd		2.04		2.07		2.09
				Pdh	kW	4.9		5.9		6.4
				PERd	%	81.6		82.9		83.6
				TOL	°C	-22				
			WTOL	°C	35					
	G Condition (-15°CDB/-)		COPd		2.60			2.56		
			Pdh	kW	6.0			7.0		
			PERd	%	103.8			102.6		
	Tbiv (bivalent tempera- ture)		COPd		2.86			2.56		
			Pdh	kW	6.5			7.0		
			PERd	%	114.4			102.6		
		Tbiv	°C	-12			-15			
	Rated heat output sup- plementary capacity		Psup (at Tdesign -22°C)	kW	4.1		3.1		2.6	
	Warm climate water outlet 35°C	General	Annual energy consumption	kWh	1,934					
			ηs (Seasonal space heating efficiency)	%	235					
Prated at 2°C			kW	8.6						
Qhe Annual energy consumption (GCV)			Gj	7						
B Condition (2°CDB/ B/1°CWB)			Cdh (Degradation heating)		1.0					
			COPd		4.06					
			Pdh	kW	6.8					
			PERd	%	162.4					
C Condition (7°CDB/ B/6°CWB)			Cdh (Degradation heating)		1.0					
			COPd		5.65					
		Pdh	kW	5.5						
		PERd	%	226.0						
Tbiv (bivalent tempera- ture)		COPd		4.73						
		Pdh	kW	6.8						
		PERd	%	189.2						
	Tbiv	°C	5							
D Condition (12°CDB/ B/11°CWB)		Cdh (Degradation heating)		1.0						
		COPd		7.52						
		Pdh	kW	6.1						
Space heating 	Warm climate water outlet 35°C	D Condition (12°CDB/ B/11°CWB)	PERd	%	300.8					

(1)Capacity according to standard EN14511 and valid for heated water range dT = 3~8°C at Ta 7°C |

(2)Condition: Ta DB/WB 7°C/6°C - LWC 35°C. (DT = 5°C) |

(3)Cooling: EW 12°C; LW 7°C; ambient conditions: 35°CDB |

(4)Cooling: EW 23°C; LW 18°C; ambient conditions: 35°CDB |

(5)Power input is total input of indoor and outdoor units, including the circulation pump; according to EN14511 |

(6)Test at Ta DB/WB 7°C/6°C. According to EN 16147. |

(7)DB/WB 7°C/6°C - LWC 35°C (dT=5°C) with pump at full speed

Technical specifications				ELVH12S18E6V + ERRA08EV3	ELVH12S23E6V + ERRA08EV3	ELVH12S18E6V + ERRA10EV3	ELVH12S23E6V + ERRA10EV3	ELVH12S18E6V + ERRA12EV3	ELVH12S23E6V + ERRA12EV3
Heating capacity	Min.		kW	3.45 (1)					
	Nom.		kW	6.17 (2)					
	Max.		kW	7.95 (1)		9.25 (1)		9.97 (1)	
Power input	Heating	Min.	kW	0.72 (3)					
		Nom.	kW	1.25 (2)					
		Max.	kW	1.69 (3)		2.04 (3)		2.28 (3)	
	Domestic hot water from 10°C to 50°C	Nom.	kWh	2.63 (4)	3.19 (4)	2.63 (4)	3.19 (4)	2.63 (4)	3.19 (4)
Heat up time from 10°C to 50°C		hr	1h 51min	2h 10min	1h 51min	2h 10min	1h 51min	2h 10min	
COP			4.92 (2)						

## 2 Specifications

### 2 - 1 Specifications

Technical specifications				ELVH12S18E6V + ERRA08EV3	ELVH12S23E6V + ERRA08EV3	ELVH12S18E6V + ERRA10EV3	ELVH12S23E6V + ERRA10EV3	ELVH12S18E6V + ERRA12EV3	ELVH12S23E6V + ERRA12EV3		
Pump	Type	Grundfos UPM4L K 15-75 130 9 DKI									
	Nominal ESP Heating unit	kPa	67.1 (5)								
Water side Heat exchanger	Water flow rate	Heating Nom.	l/min	18.3							
General	Supplier/Manufacturer details	Name and address	Daikin Europe N.V. - Zandvoordestraat 300, 8400 Oostende, Belgium								
		Name or trademark	Daikin Europe N.V.								
	Product description	Air-to-water heat pump	Yes								
		Brine-to-water heat pump	No								
		Heat pump combination heater	Yes								
		Low-temperature heat pump	No								
		Supplementary heater integrated	Yes								
Water-to-water heat pump	No										
LW(A) Sound power level (according to EN14825)	Indoor	dB(A)	44.0								
LW(A) Sound power level (according to EN14825)	Outdoor	dB(A)	56.0								
Sound condition Ecodesign and energy label				Sound power in heating mode, measured according to the EN12102 under conditions of the EN14825							
Tank	Name	Stainless steel domestic hot water tank 180 l	Stainless steel domestic hot water tank 230 L	Stainless steel domestic hot water tank 180 l	Stainless steel domestic hot water tank 230 L	Stainless steel domestic hot water tank 180 l	Stainless steel domestic hot water tank 230 L	Stainless steel domestic hot water tank 180 l	Stainless steel domestic hot water tank 230 L		
		Space heating general	Air to water unit	Rated airflow (outdoor)	m <sup>3</sup> /h	3,542					
		Other	Capacity control	Inverter							
			Pck (Crankcase heater mode)	kW	0.000						
			Poff (Off mode)	kW	0.021						
			Psb (Standby mode)	kW	0.021						
Pto (Thermostat off)	kW	0.024									
Domestic hot water heating	General	Declared load profile	L								
Space heating general	Integrated supplementary heater	Psup	kW	6.0							
		Type of energy input	Electrical								
Domestic hot water heating	Average climate	AEC (Annual electricity consumption)	kWh	877	810	877	810	877	810		
		COPdhw		2.72	2.96	2.72	2.96	2.72	2.96		
		Heat up time		1h 57min	2h 14min	1h 57min	2h 14min	1h 57min	2h 14min		
Domestic hot water heating	Average climate	η <sub>wh</sub> (water heating efficiency)	%	117	126	117	126	117	126		
		Qelec (Daily electricity consumption)	kWh	4.280	3.940	4.280	3.940	4.280	3.940		
		Reference hot water temperature	°C	53.0	52.0	53.0	52.0	53.0	52.0		
		Stand-by power input	W	51.7	44.8	51.7	44.8	51.7	44.8		
		Water heating energy efficiency class	A+								
		Cold climate	AEC (Annual electricity consumption)	kWh	966	891	966	891	966	891	
COPdhw			2.48	2.70	2.48	2.70	2.48	2.70			
Heat up time			1h 55min	2h 02min	1h 55min	2h 02min	1h 55min	2h 02min			
η <sub>wh</sub> (water heating efficiency)	%		106	115	106	115	106	115			
Qelec (Daily electricity consumption)	kWh		4.700	4.320	4.700	4.320	4.700	4.320			
Reference hot water temperature	°C		53.0	52.0	53.0	52.0	53.0	52.0			
Stand-by power input	W		55.4	47.7	55.4	47.7	55.4	47.7			
Warm climate	AEC (Annual electricity consumption)		kWh	719	666	719	666	719	666		
	COPdhw			3.31	3.59	3.31	3.59	3.31	3.59		
	Heat up time			1h 54min	2h 06min	1h 54min	2h 06min	1h 54min	2h 06min		
	η <sub>wh</sub> (water heating efficiency)	%	142	154	142	154	142	154			
	Qelec (Daily electricity consumption)	kWh	3.530	3.250	3.530	3.250	3.530	3.250			
	Reference hot water temperature	°C	53.0	52.0	53.0	52.0	53.0	52.0			
Stand-by power input	W	45.4	39.7	45.4	39.7	45.4	39.7				

## 2 Specifications

### 2 - 1 Specifications

Technical specifications				ELVH12S18E6V + ERRA08EV3	ELVH12S23E6V + ERRA08EV3	ELVH12S18E6V + ERRA10EV3	ELVH12S23E6V + ERRA10EV3	ELVH12S18E6V + ERRA12EV3	ELVH12S23E6V + ERRA12EV3			
Space heating	Average climate water outlet 55°C	General	Annual energy consumption	kWh	7,742		7,723		7,510			
			ηs (Seasonal space heating efficiency)	%	130		131		135			
			Prated at -10°C	kW			12.5					
			Qhe Annual energy consumption (GCV)	Gj		28			27			
			SCOP			3.34			3.44			
			Seasonal space heating eff. class				A++					
			A Condition (-7°CDB/-8°CWB)	Cdh (Degradation heating)				1.0				
				COPd				2.26				
				Pdh	kW			7.6				
				PERd	%			90.4				
			B Condition (2°CDB/1°CWB)	Cdh (Degradation heating)				1.0				
				COPd				3.39				
				Pdh	kW			6.8				
				PERd	%			135.6				
			C Condition (7°CDB/6°CWB)	Cdh (Degradation heating)				1.0				
				COPd				4.90				
				Pdh	kW			4.5				
				PERd	%			196.0				
			Space heating	Average climate water outlet 55°C	D Condition (12°CDB/11°CWB)	Cdh (Degradation heating)				1.0		
						COPd				6.02		
Pdh	kW							5.2				
PERd	%							240.8				
Tol (temperature operating limit)	COPd					1.97			2.00			
	Pdh	kW				6.9			8.2			
	PERd	%				78.8			80.0			
	TOL	°C							-10			
	WTOL	°C							55			
Rated heat output supplementary capacity	Psup (at Tdesign -10°C)	kW				5.6			4.3			
Tbiv (bivalent temperature)	COPd						2.81			2.41		
	Pdh	kW					8.5			10.0		
	PERd	%					112.4			96.4		
	Tbiv	°C					-2			-5		
Cold climate water outlet 55°C	General	Annual energy consumption				kWh	7,303		7,173		7,146	
		ηs (Seasonal space heating efficiency)				%	118			121		
		Prated at -22°C				kW				9.0		
		Qhe Annual energy consumption (GCV)				Gj				26		
		A Condition (-7°CDB/-8°CWB)				Cdh (Degradation heating)				1.0		
						COPd				2.52		
			Pdh	kW			5.2					
			PERd	%			100.6					
		B Condition (2°CDB/1°CWB)	Cdh (Degradation heating)				1.0					
			COPd				3.77					
			Pdh	kW			3.3					
			PERd	%			151.0					
		C Condition (7°CDB/6°CWB)	Cdh (Degradation heating)				1.0					
			COPd				4.81					
			Pdh	kW			3.4					
			PERd	%			192.2					
		D Condition (12°CDB/11°CWB)	COPd				6.36					
			Pdh	kW			4.2					
			PERd	%			254.2					
		Tol (temperature operating limit)	COPd		1.43			1.49	1.54			
	Pdh	kW	4.9			6.1	7.2					
	PERd	%	57.4			59.7	61.7					
	TOL	°C				-22						

## 2 Specifications

### 2 - 1 Specifications

Technical specifications				ELVH12S18E6V + ERRA08EV3	ELVH12S23E6V + ERRA08EV3	ELVH12S18E6V + ERRA10EV3	ELVH12S23E6V + ERRA10EV3	ELVH12S18E6V + ERRA12EV3	ELVH12S23E6V + ERRA12EV3		
Space heating 	Cold climate water outlet 55°C	Tol (tem- perature operating limit)	WTOL °C	55							
		G Condition (-15°CDB/-)	COPd	1.93					1.96		
			Pdh	kW	6.0					7.2	
			PERd	%	77.2					78.4	
		Tbiv (bivalent tempera- ture)	COPd	2.17					1.96		
			Pdh	kW	6.6					7.2	
			PERd	%	86.9					78.4	
		Rated heat output sup- plementary capacity	Tbiv	°C	-12					-15	
			Psup (at Tdesign -22°C)	kW	4.1			2.9			1.8
		Warm climate water outlet 55°C	General	Annual energy consumption	kWh	3,039					
ηs (Seasonal space heating efficiency)	%			166							
Prated at 2°C	kW			9.6							
Qhe Annual energy consumption (GCV)	Gj			11							
B Condition (2°CDB- B/1°CWB)	Cdh (Degradation heating)			1.0							
	COPd			2.57							
	Pdh		kW	8.0							
	PERd		%	102.6							
C Condition (7°CDB- B/6°CWB)	Cdh (Degradation heating)			1.0							
	COPd			3.65							
	Pdh		kW	6.7							
	PERd		%	146.2							
D Condition (12°CDB- B/11°CWB)	Cdh (Degradation heating)			1.0							
	COPd			5.71							
	Pdh		kW	3.6							
	PERd		%	228.3							
Tbiv (bivalent tempera- ture)	COPd			3.02							
	Pdh	kW	8.4								
	PERd	%	120.9								
	Tbiv	°C	4								
Average climate water outlet 35°C	General	Annual energy consumption	kWh	3,659					3,637		
		ηs (Seasonal space heating efficiency)	%	184					186		
		Prated at -10°C	kW	8.3							
		Qhe Annual energy consumption (GCV)	Gj	13							
		SCOP		4.69					4.71		
	Seasonal space heating eff. class		A+++								
	A Condition (-7°CDB/-8°CWB)	COPd		3.10							
Pdh	kW	7.5									

## 2 Specifications

### 2 - 1 Specifications

2

Technical specifications				ELVH12S18E6V + ERRA08EV3	ELVH12S23E6V + ERRA08EV3	ELVH12S18E6V + ERRA10EV3	ELVH12S23E6V + ERRA10EV3	ELVH12S18E6V + ERRA12EV3	ELVH12S23E6V + ERRA12EV3		
Space heating Average climate water outlet 35°C	A Condition (-7°C- B/-8°CWB)	PERd	%	124.1							
	B Condition (2°C- B/1°CWB)	Cdh (Degradation heating)		1.0							
		COPd		4.76							
		Pdh	kW	4.4							
		PERd	%	190.4							
	C Condition (7°C- B/6°CWB)	Cdh (Degradation heating)		1.0							
		COPd		6.14							
		Pdh	kW	4.3							
		PERd	%	245.8							
	D Condition (12°C- B/11°CWB)	Cdh (Degradation heating)		1.0							
		COPd		7.84							
		Pdh	kW	6.6							
		PERd	%	313.4							
	Tol (tem- perature operating limit)	COPd		2.80					2.77		
		Pdh	kW	6.9					8.1		
		PERd	%	112.2					110.8		
		TOL	°C						-10		
	Tbiv (bivalent tempera- ture)	WTOL	°C						35		
		COPd		3.10					2.77		
		Pdh	kW	7.5					8.1		
		PERd	%	124.1					110.8		
	Rated heat output sup- plementary capacity	Tbiv	°C	-7					-10		
		Psup (at Tdesign -10°C)	kW	1.4					0.0		
	Cold climate water outlet 35°C	General	Annual energy consumption	kWh	5,554		5,401		5,387		
ηs (Seasonal space heating efficiency)			%	157		161		162			
Prated at -22°C			kW			9					
A Condition (-7°C- B/-8°CWB)		Qhe Annual energy consumption (GCV)	Gj	20.0				19.4			
		COPd						3.36			
		Pdh	kW					5.4			
B Condition (2°C- B/1°CWB)	PERd	%					134.5				
	Cdh (Degradation heating)						1.0				
	COPd						5.21				
C Condition (7°C- B/6°CWB)	Pdh	kW					3.6				
	PERd	%					208.4				
	Cdh (Degradation heating)						1.0				
D Condition (12°C- B/11°CWB)	COPd						6.29				
	Pdh	kW					5.3				

## 2 Specifications

### 2 - 1 Specifications

Technical specifications				ELVH12S18E6V + ERRA08EV3	ELVH12S23E6V + ERRA08EV3	ELVH12S18E6V + ERRA10EV3	ELVH12S23E6V + ERRA10EV3	ELVH12S18E6V + ERRA12EV3	ELVH12S23E6V + ERRA12EV3
Space heating 	Cold climate water outlet 35°C	C Condition (7°CDB/ B/6°CWB)	PERd	%	251.7				
			D Condition (12°CDB/ B/11°CWB)	Cdh (Degradation heating)		1.0			
			COPd		7.69				
			Pdh	kW	6.6				
			PERd	%	307.6				
		Tol (tem- perature operating limit)	COPd		2.04		2.07		2.09
				Pdh	kW	4.9		5.9	
			PERd	%	81.6		82.9		83.6
			TOL	°C	-22				
		G Condition (-15°CDB/-)	COPd		2.60			2.56	
	Pdh		kW	6.0			7.0		
	PERd		%	103.8			102.6		
	Tbiv (bivalent tempera- ture)	COPd		2.86			2.56		
		Pdh	kW	6.5			7.0		
		PERd	%	114.4			102.6		
	Rated heat output sup- plementary capacity	Psup (at Tdesign -22°C)	kW	4.1		3.1		2.6	
	Warm climate water outlet 35°C	General	Annual energy consumption	kWh	2,027				
			ηs (Seasonal space heating efficiency)	%	224				
			Prated at 2°C	kW	8.6				
			Qhe Annual energy consumption (GCV)	Gj	7				
		B Condition (2°CDB/ B/1°CWB)	Cdh (Degradation heating)		1.0				
			COPd		4.06				
			Pdh	kW	6.8				
			PERd	%	162.4				
		C Condition (7°CDB/ B/6°CWB)	Cdh (Degradation heating)		1.0				
			COPd		5.65				
Pdh			kW	5.5					
PERd			%	226.0					
Tbiv (bivalent tempera- ture)		COPd		4.73					
		Pdh	kW	6.8					
		PERd	%	189.2					
		Tbiv	°C	5					
D Condition (12°CDB/ B/11°CWB)		Cdh (Degradation heating)		1.0					
	COPd		7.52						
	Pdh	kW	6.1						
Space heating 	Warm climate water outlet 35°C	D Condition (12°CDB/ B/11°CWB)	PERd	%	300.8				

(1)Capacity according to standard EN14511 and valid for heated water range dT = 3~8°C at Ta 7°C |

(2)Condition: Ta DB/WB 7°C/6°C - LWC 35°C. (DT = 5°C) |

(3)Power input is total input of indoor and outdoor units, including the circulation pump; according to EN14511 |

(4)Test at Ta DB/WB 7°C/6°C. According to EN 16147. |

(5)DB/WB 7°C/6°C - LWC 35°C (dT=5°C) with pump at full speed |

Cooling: EW 12°C; LW 7°C; ambient conditions: 35°CDB |

Cooling: EW 23°C; LW 18°C; ambient conditions: 35°CDB

Technical specifications				ELVH12S18E9W + ERRA08EV3	ELVH12S23E9W + ERRA08EV3	ELVH12S18E9W + ERRA10EV3	ELVH12S23E9W + ERRA10EV3	ELVH12S18E9W + ERRA12EV3	ELVH12S23E9W + ERRA12EV3
Heating capacity	Min.	kW	3.45 (1)						
	Nom.	kW	6.17 (2)						
	Max.	kW	7.95 (1)		9.25 (1)		9.97 (1)		
Power input	Heating	Min.	0.72 (3)						
		Nom.	1.25 (2)						
		Max.	1.69 (3)		2.04 (3)		2.28 (3)		
	Domestic hot water from 10°C to 50°C	Nom.	kWh	2.63 (4)	3.19 (4)	2.63 (4)	3.19 (4)	2.63 (4)	3.19 (4)
Heat up time from 10°C to 50°C			hr	1h 51min	2h 10min	1h 51min	2h 10min	1h 51min	2h 10min
COP				4.92 (2)					

## 2 Specifications

### 2 - 1 Specifications

2

Technical specifications				ELVH12S18E9W + ERRA08EV3	ELVH12S23E9W + ERRA08EV3	ELVH12S18E9W + ERRA10EV3	ELVH12S23E9W + ERRA10EV3	ELVH12S18E9W + ERRA12EV3	ELVH12S23E9W + ERRA12EV3		
Pump	Type	Grundfos UPM4L K 15-75 130 9 DKI									
	Nominal ESP Heating unit	kPa	67.1 (5)								
Water side Heat exchanger	Water flow rate	Heating Nom.	l/min	18.3							
General	Supplier/Manufacturer details	Name and address		Daikin Europe N.V. - Zandvoordestraat 300, 8400 Oostende, Belgium							
		Name or trademark		Daikin Europe N.V.							
	Product description	Air-to-water heat pump			Yes						
		Brine-to-water heat pump			No						
		Heat pump combination heater			Yes						
		Low-temperature heat pump			No						
		Supplementary heater integrated			Yes						
Water-to-water heat pump			No								
LW(A) Sound power level (according to EN14825)	Indoor		dB(A)	44.0							
LW(A) Sound power level (according to EN14825)	Outdoor		dB(A)	56.0							
Sound condition Ecodesign and energy label				Sound power in heating mode, measured according to the EN12102 under conditions of the EN14825							
Tank	Name			Stainless steel domestic hot water tank 180 l	Stainless steel domestic hot water tank 230 L	Stainless steel domestic hot water tank 180 l	Stainless steel domestic hot water tank 230 L	Stainless steel domestic hot water tank 180 l	Stainless steel domestic hot water tank 230 L		
		Space heating general	Air to water unit	Rated airflow (outdoor)	m <sup>3</sup> /h	3,542					
			Other	Capacity control		Inverter					
				Pck (Crankcase heater mode)	kW	0.000					
				Poff (Off mode)	kW	0.021					
				Psb (Standby mode)	kW	0.021					
		Pto (Thermostat off)	kW	0.024							
Domestic hot water heating	General	Declared load profile		L							
Space heating general	Integrated supplementary heater	Psup	kW	9.0							
		Type of energy input		Electrical							
Domestic hot water heating	Average climate	AEC (Annual electricity consumption)	kWh	877	810	877	810	877	810		
		COPdhw		2.72	2.96	2.72	2.96	2.72	2.96		
		Heat up time		1h 57min	2h 14min	1h 57min	2h 14min	1h 57min	2h 14min		
Domestic hot water heating	Average climate	η <sub>wh</sub> (water heating efficiency)	%	117	126	117	126	117	126		
		Qelec (Daily electricity consumption)	kWh	4.280	3.940	4.280	3.940	4.280	3.940		
		Reference hot water temperature	°C	53.0	52.0	53.0	52.0	53.0	52.0		
		Stand-by power input	W	51.7	44.8	51.7	44.8	51.7	44.8		
		Water heating energy efficiency class		A+							
Domestic hot water heating	Cold climate	AEC (Annual electricity consumption)	kWh	966	891	966	891	966	891		
		COPdhw		2.48	2.70	2.48	2.70	2.48	2.70		
		Heat up time		1h 55min	2h 02min	1h 55min	2h 02min	1h 55min	2h 02min		
		η <sub>wh</sub> (water heating efficiency)	%	106	115	106	115	106	115		
		Qelec (Daily electricity consumption)	kWh	4.700	4.320	4.700	4.320	4.700	4.320		
	Reference hot water temperature	°C	53.0	52.0	53.0	52.0	53.0	52.0			
	Stand-by power input	W	55.4	47.7	55.4	47.7	55.4	47.7			
	Warm climate	AEC (Annual electricity consumption)	kWh	719	666	719	666	719	666		
		COPdhw		3.31	3.59	3.31	3.59	3.31	3.59		
		Heat up time		1h 54min	2h 06min	1h 54min	2h 06min	1h 54min	2h 06min		
η <sub>wh</sub> (water heating efficiency)		%	142	154	142	154	142	154			
Qelec (Daily electricity consumption)		kWh	3.530	3.250	3.530	3.250	3.530	3.250			
Reference hot water temperature	°C	53.0	52.0	53.0	52.0	53.0	52.0				
Stand-by power input	W	45.4	39.7	45.4	39.7	45.4	39.7				

## 2 Specifications

### 2 - 1 Specifications

Technical specifications				ELVH12S18E9W + ERRA08EV3	ELVH12S23E9W + ERRA08EV3	ELVH12S18E9W + ERRA10EV3	ELVH12S23E9W + ERRA10EV3	ELVH12S18E9W + ERRA12EV3	ELVH12S23E9W + ERRA12EV3			
Space heating 	Average climate water outlet 55°C	General	Annual energy consumption	kWh	7,742		7,723		7,510			
			ηs (Seasonal space heating efficiency)	%	130		131		135			
			Prated at -10°C	kW				12.5				
			Qhe Annual energy consumption (GCV)	Gj		28			27			
			SCOP			3.34			3.44			
			Seasonal space heating eff. class					A++				
			A Condition (-7°CDB/-8°CWB)	Cdh (Degradation heating)				1.0				
				COPd				2.26				
				Pdh	kW			7.6				
				PERd	%			90.4				
			B Condition (2°CDB/1°CWB)	Cdh (Degradation heating)				1.0				
				COPd				3.39				
				Pdh	kW			6.8				
				PERd	%			135.6				
			C Condition (7°CDB/6°CWB)	Cdh (Degradation heating)				1.0				
				COPd				4.90				
				Pdh	kW			4.5				
				PERd	%			196.0				
			Space heating 	Average climate water outlet 55°C	D Condition (12°CDB/11°CWB)	Cdh (Degradation heating)				1.0		
						COPd				6.02		
	Pdh	kW						5.2				
	PERd	%						240.8				
Tol (temperature operating limit)	COPd					1.97			2.00			
	Pdh	kW				6.9			8.2			
	PERd	%				78.8			80.0			
	TOL	°C							-10			
	WTOL	°C							55			
Rated heat output supplementary capacity	Psup (at Tdesign -10°C)	kW				5.6			4.3			
	Tbiv (bivalent temperature)	COPd					2.81			2.41		
		Pdh				kW		8.5		10.0		
		PERd				%		112.4		96.4		
		Tbiv				°C		-2		-5		
Cold climate water outlet 55°C	General	Annual energy consumption				kWh	7,303		7,173		7,146	
		ηs (Seasonal space heating efficiency)				%	118			121		
		Prated at -22°C				kW				9.0		
		Qhe Annual energy consumption (GCV)				Gj				26		
		A Condition (-7°CDB/-8°CWB)				Cdh (Degradation heating)				1.0		
						COPd				2.52		
			Pdh	kW			5.2					
			PERd	%			100.6					
		B Condition (2°CDB/1°CWB)	Cdh (Degradation heating)				1.0					
			COPd				3.77					
			Pdh	kW			3.3					
			PERd	%			151.0					
		C Condition (7°CDB/6°CWB)	Cdh (Degradation heating)				1.0					
			COPd				4.81					
			Pdh	kW			3.4					
			PERd	%			192.2					
		D Condition (12°CDB/11°CWB)	COPd				6.36					
			Pdh	kW			4.2					
			PERd	%			254.2					
		Tol (temperature operating limit)	COPd		1.43			1.49		1.54		
Pdh	kW		4.9			6.1		7.2				
PERd	%		57.4			59.7		61.7				
TOL	°C					-22						

## 2 Specifications

### 2 - 1 Specifications

2

Technical specifications				ELVH12S18E9W + ERRA08EV3	ELVH12S23E9W + ERRA08EV3	ELVH12S18E9W + ERRA10EV3	ELVH12S23E9W + ERRA10EV3	ELVH12S18E9W + ERRA12EV3	ELVH12S23E9W + ERRA12EV3	
Space heating 	Cold climate water outlet 55°C	Tol (tem- perature operating limit)	WTOL °C	55						
		G Condition (-15°CDB/-)	COPd	1.93					1.96	
			Pdh kW	6.0					7.2	
			PERd %	77.2					78.4	
		Tbiv (bivalent tempera- ture)	COPd	2.17					1.96	
			Pdh kW	6.6					7.2	
			PERd %	86.9					78.4	
		Rated heat output sup- plementary capacity	Psup (at Tdesign -22°C)	kW	4.1		2.9		1.8	
		Warm climate water outlet 55°C	General	Annual energy consumption	kWh	3,039				
ηs (Seasonal space heating efficiency)	%			166						
Prated at 2°C	kW			9.6						
Qhe Annual energy consumption (GCV)	Gj			11						
B Condition (2°CDB- B/1°CWB)	Cdh (Degradation heating)			1.0						
	COPd			2.57						
	Pdh kW			8.0						
	PERd %			102.6						
C Condition (7°CDB- B/6°CWB)	Cdh (Degradation heating)			1.0						
	COPd			3.65						
	Pdh kW			6.7						
	PERd %			146.2						
D Condition (12°CDB- B/11°CWB)	Cdh (Degradation heating)			1.0						
	COPd			5.71						
	Pdh kW			3.6						
	PERd %			228.3						
Tbiv (bivalent tempera- ture)	COPd			3.02						
	Pdh kW			8.4						
	PERd %			120.9						
	Tbiv °C		4							
Average climate water outlet 35°C	General	Annual energy consumption	kWh	3,659		3,637				
		ηs (Seasonal space heating efficiency)	%	184		186				
		Prated at -10°C	kW	8.3						
		Qhe Annual energy consumption (GCV)	Gj	13						
		SCOP		4.69		4.71				
	Seasonal space heating eff. class			A+++						
	A Condition (-7°CDB/-8°CWB)	COPd		3.10						
Pdh kW			7.5							

## 2 Specifications

### 2 - 1 Specifications

Technical specifications				ELVH12S18E9W + ERRA08EV3	ELVH12S23E9W + ERRA08EV3	ELVH12S18E9W + ERRA10EV3	ELVH12S23E9W + ERRA10EV3	ELVH12S18E9W + ERRA12EV3	ELVH12S23E9W + ERRA12EV3	
Space heating 	Average climate water outlet	A Condition (-7°C-D B/-8°CWB)	PERd	%	124.1					
		B Condition (2°C-D B/1°CWB)	Cdh (Degradation heating)			1.0				
	COPd				4.76					
	Pdh			kW	4.4					
	PERd			%	190.4					
	C Condition (7°C-D B/6°CWB)	Cdh (Degradation heating)			1.0					
		COPd			6.14					
		Pdh		kW	4.3					
		PERd		%	245.8					
	D Condition (12°C-D B/11°CWB)	Cdh (Degradation heating)			1.0					
		COPd			7.84					
		Pdh		kW	6.6					
		PERd		%	313.4					
	Tol (temperature operating limit)	COPd			2.80				2.77	
		Pdh		kW	6.9				8.1	
		PERd		%	112.2				110.8	
		TOL		°C				-10		
	Tbiv (bivalent temperature)	WTOL		°C				35		
		COPd			3.10				2.77	
		Pdh		kW	7.5				8.1	
		PERd		%	124.1				110.8	
	Rated heat output supplementary capacity	Tbiv		°C	-7				-10	
		Psup (at Tdesign -10°C)		kW	1.4				0.0	
	Cold climate water outlet 35°C	General	Annual energy consumption	kWh	5,554		5,401		5,387	
			ηs (Seasonal space heating efficiency)	%	157		161		162	
Prated at -22°C			kW				9			
Qhe Annual energy consumption (GCV)			Gj	20.0			19.4			
A Condition (-7°C-D B/-8°CWB)			COPd					3.36		
B Condition (2°C-D B/1°CWB)	Pdh		kW			5.4				
	PERd		%			134.5				
	Cdh (Degradation heating)					1.0				
C Condition (7°C-D B/6°CWB)	COPd					5.21				
	Pdh		kW			3.6				
	PERd		%			208.4				
D Condition (12°C-D B/11°CWB)	Cdh (Degradation heating)					1.0				
	COPd					6.29				
	Pdh		kW			5.3				

## 2 Specifications

### 2 - 1 Specifications

2

Technical specifications				ELVH12S18E9W + ERRA08EV3	ELVH12S23E9W + ERRA08EV3	ELVH12S18E9W + ERRA10EV3	ELVH12S23E9W + ERRA10EV3	ELVH12S18E9W + ERRA12EV3	ELVH12S23E9W + ERRA12EV3	
Space heating 	Cold climate water outlet 35°C	C Condition (7°CDB/ B/6°CWB)	PERd	%	251.7					
			D Condition (12°CDB/ B/11°CWB)		Cdh (Degradation heating)		1.0			
			COPd		7.69					
		Pdh		6.6						
		PERd		307.6						
		Tol (tem- perature operating limit)	COPd		2.04		2.07		2.09	
			Pdh		4.9		5.9		6.4	
			PERd		81.6		82.9		83.6	
			TOL		-22					
			WTOL		35					
		G Condition (-15°CDB/-)	COPd		2.60			2.56		
			Pdh		6.0			7.0		
	PERd		103.8			102.6				
	Tbiv (bivalent tempera- ture)	COPd		2.86			2.56			
		Pdh		6.5			7.0			
		PERd		114.4			102.6			
		Tbiv		-12			-15			
	Rated heat output sup- plementary capacity	Psup (at Tdesign -22°C)		4.1		3.1		2.6		
		Warm climate water outlet 35°C	General	Annual energy consumption	kWh	2,027				
	ηs (Seasonal space heating efficiency)			%	224					
	Prated at 2°C			kW	8.6					
	Qhe Annual energy consumption (GCV)		Gj	7						
	B Condition (2°CDB/ B/1°CWB)		Cdh (Degradation heating)		1.0					
			COPd		4.06					
Pdh		6.8								
PERd		162.4								
C Condition (7°CDB/ B/6°CWB)	Cdh (Degradation heating)		1.0							
	COPd		5.65							
	Pdh		5.5							
	PERd		226.0							
Tbiv (bivalent tempera- ture)	COPd		4.73							
	Pdh		6.8							
	PERd		189.2							
	Tbiv		5							
D Condition (12°CDB/ B/11°CWB)	Cdh (Degradation heating)		1.0							
	COPd		7.52							
	Pdh		6.1							
Space heating 	Warm climate water outlet 35°C	D Condition (12°CDB/ B/11°CWB)	PERd	%	300.8					

(1)Capacity according to standard EN14511 and valid for heated water range dT = 3~8°C at Ta 7°C |

(2)Condition: Ta DB/WB 7°C/6°C - LWC 35°C. (DT = 5°C) |

(3)Power input is total input of indoor and outdoor units, including the circulation pump; according to EN14511 |

(4)Test at Ta DB/WB 7°C/6°C. According to EN 16147. |

(5)DB/WB 7°C/6°C - LWC 35°C (dT=5°C) with pump at full speed |

Cooling: EW 12°C; LW 7°C; ambient conditions: 35°CDB |

Cooling: EW 23°C; LW 18°C; ambient conditions: 35°CDB

Technical specifications				ELVX12S18E6V + ERRA08EV3	ELVX12S23E6V + ERRA08EV3	ELVX12S18E6V + ERRA10EV3	ELVX12S23E6V + ERRA10EV3	ELVX12S18E6V + ERRA12EV3	ELVX12S23E6V + ERRA12EV3	
Heating capacity	Min.	kW		3.45 (1)						
	Nom.	kW		6.17 (2)						
	Max.	kW		7.95 (1)		9.25 (1)		9.97 (1)		
Cooling capacity	Nom.	kW		6.81 (3) / 6.47 (4)		7.97 (3) / 6.47 (4)		8.62 (3) / 6.47 (4)		
Power input	Heating	Min.	kW		0.72 (5)					
		Nom.	kW		1.25 (2)					
		Max.	kW		1.69 (5)		2.04 (5)		2.28 (5)	
	Cooling	Nom.	kW		2.15 (3) / 1.16 (4)		2.66 (3) / 1.16 (4)		2.96 (3) / 1.16 (4)	
		Domestic hot water from 10°C to 50°C	Nom.	kWh	2.63 (6)	3.19 (6)	2.63 (6)	3.19 (6)	2.63 (6)	3.19 (6)
		Heat up time from 10°C to 50°C		hr	1h 51min	2h 10min	1h 51min	2h 10min	1h 51min	2h 10min
COP				4.92 (2)						

## 2 Specifications

### 2 - 1 Specifications

Technical specifications				ELVX12S18E6V + ERRA08EV3	ELVX12S23E6V + ERRA08EV3	ELVX12S18E6V + ERRA10EV3	ELVX12S23E6V + ERRA10EV3	ELVX12S18E6V + ERRA12EV3	ELVX12S23E6V + ERRA12EV3	
EER				3.17 (3) / 5.56 (4)		3.00 (3) / 5.56 (4)		2.91 (3) / 5.56 (4)		
Pump	Type				Grundfos UPM4L K 15-75 130 9 DK1					
	Nominal ESP unit	Heating	kPa	671 (7)						
Water side Heat exchanger	Water flow rate	Heating	Nom.	l/min			18.3			
General	Supplier/Manufacturer details	Name and address		Daikin Europe N.V. - Zandvoordestraat 300, 8400 Oostende, Belgium						
	Product description	Name or trademark		Daikin Europe N.V.						
		Air-to-water heat pump		Yes						
		Brine-to-water heat pump		No						
		Heat pump combination heater		Yes						
		Low-temperature heat pump		No						
		Supplementary heater integrated		Yes						
	LW(A) Sound power level (according to EN14825)	Indoor	dB(A)		44.0					
		Outdoor	dB(A)		56.0					
	Sound condition Ecodesign and energy label				Sound power in heating mode, measured according to the EN12102 under conditions of the EN14825					
Tank	Name	Stainless steel domestic hot water tank 180 l	Stainless steel domestic hot water tank 230 L	Stainless steel domestic hot water tank 180 l	Stainless steel domestic hot water tank 230 L	Stainless steel domestic hot water tank 180 l	Stainless steel domestic hot water tank 230 L	Stainless steel domestic hot water tank 180 l	Stainless steel domestic hot water tank 230 L	
		Space heating general	Air to water unit	Rated airflow (outdoor)	m <sup>3</sup> /h		3,542			
		Other	Capacity control		Inverter					
			Pck (Crankcase heater mode)		kW		0.000			
			Poff (Off mode)		kW		0.021			
			Psb (Standby mode)		kW		0.021			
Domestic hot water heating	General	Pto (Thermostat off)		kW		0.024				
		Declared load profile		L						
Space heating general	Integrated supplementary heater	Psup	kW		6.0					
Domestic hot water heating	Average climate	Type of energy input		Electrical						
		AEC (Annual electricity consumption)	kWh		877	810	877	810	877	810
		COPdhw			2.72	2.96	2.72	2.96	2.72	2.96
		Heat up time			1h 57min	2h 14min	1h 57min	2h 14min	1h 57min	2h 14min
		η <sub>wh</sub> (water heating efficiency)	%		117	126	117	126	117	126
		Qelec (Daily electricity consumption)	kWh		4.280	3.940	4.280	3.940	4.280	3.940
		Reference hot water temperature	°C		53.0	52.0	53.0	52.0	53.0	52.0
		Stand-by power input	W		51.7	44.8	51.7	44.8	51.7	44.8
		Water heating energy efficiency class		A+						
		Cold climate	AEC (Annual electricity consumption)	kWh		966	891	966	891	966
	COPdhw				2.48	2.70	2.48	2.70	2.48	2.70
	Heat up time				1h 55min	2h 02min	1h 55min	2h 02min	1h 55min	2h 02min
	η <sub>wh</sub> (water heating efficiency)		%		106	115	106	115	106	115
	Qelec (Daily electricity consumption)		kWh		4.700	4.320	4.700	4.320	4.700	4.320
	Reference hot water temperature		°C		53.0	52.0	53.0	52.0	53.0	52.0
	Stand-by power input		W		55.4	47.7	55.4	47.7	55.4	47.7
	Warm climate	AEC (Annual electricity consumption)	kWh		719	666	719	666	719	666
		COPdhw			3.31	3.59	3.31	3.59	3.31	3.59
Heat up time				1h 54min	2h 06min	1h 54min	2h 06min	1h 54min	2h 06min	
η <sub>wh</sub> (water heating efficiency)		%		142	154	142	154	142	154	
Qelec (Daily electricity consumption)		kWh		3.530	3.250	3.530	3.250	3.530	3.250	
Reference hot water temperature		°C		53.0	52.0	53.0	52.0	53.0	52.0	
Stand-by power input	W		45.4	39.7	45.4	39.7	45.4	39.7		

# 2 Specifications

## 2 - 1 Specifications

2

Technical specifications				ELVX12S18E6V + ERRA08EV3	ELVX12S23E6V + ERRA08EV3	ELVX12S18E6V + ERRA10EV3	ELVX12S23E6V + ERRA10EV3	ELVX12S18E6V + ERRA12EV3	ELVX12S23E6V + ERRA12EV3		
Space heating	Average climate water outlet 55°C	General	Annual energy consumption	kWh	7,664		7,645		7,433		
			ηs (Seasonal space heating efficiency)	%		132			136		
			Prated at -10°C	kW			12.5				
			Qhe Annual energy consumption (GCV)	Gj		28			27		
			SCOP		3.37		3.38		3.47		
			Seasonal space heating eff. class				A++				
			A Condition (-7°CDB/-8°CWB)	Cdh (Degradation heating)			1.0				
				COPd			2.26				
				Pdh	kW		7.6				
				PERd	%		90.4				
			B Condition (2°CDB/1°CWB)	Cdh (Degradation heating)			1.0				
				COPd			3.39				
				Pdh	kW		6.8				
				PERd	%		135.6				
			C Condition (7°CDB/6°CWB)	Cdh (Degradation heating)			1.0				
			Space heating	Average climate water outlet 55°C	C Condition (7°CDB/6°CWB)	COPd			4.90		
						Pdh	kW		4.5		
PERd	%					196.0					
D Condition (12°CDB/11°CWB)	Cdh (Degradation heating)						1.0				
	COPd						6.02				
	Pdh	kW					5.2				
	PERd	%					240.8				
Tol (temperature operating limit)	COPd					1.97		2.00			
	Pdh	kW				6.9		8.2			
	PERd	%				78.8		80.0			
	TOL	°C						-10			
	WTOL	°C						55			
Rated heat output supplementary capacity	Psup (at Tdesign -10°C)	kW				5.6			4.3		
Tbiv (bivalent temperature)	COPd						2.81		2.41		
	Pdh	kW					8.5		10.0		
	PERd	%					112.4		96.4		
	Tbiv	°C					-2		-5		
Cold climate water outlet 55°C	General	Annual energy consumption	kWh	7,257		7,127		7,100			
		ηs (Seasonal space heating efficiency)	%	119			122				
		Prated at -22°C	kW			9.0					
		Qhe Annual energy consumption (GCV)	Gj			26					
		A Condition (-7°CDB/-8°CWB)	Cdh (Degradation heating)			1.0					
			COPd			2.52					
			Pdh	kW		5.2					
			PERd	%		100.6					
		B Condition (2°CDB/1°CWB)	Cdh (Degradation heating)			1.0					
			COPd			3.77					
			Pdh	kW		3.3					
			PERd	%		151.0					
		C Condition (7°CDB/6°CWB)	Cdh (Degradation heating)			1.0					
			COPd			4.81					
			Pdh	kW		3.4					
			PERd	%		192.2					
		D Condition (12°CDB/11°CWB)	COPd			6.36					
	Pdh	kW		4.2							
	PERd	%		254.2							
Tol (temperature operating limit)	COPd		1.43		1.49		1.54				

## 2 Specifications

### 2 - 1 Specifications

Technical specifications					ELVX12S18E6V + ERRA08EV3	ELVX12S23E6V + ERRA08EV3	ELVX12S18E6V + ERRA10EV3	ELVX12S23E6V + ERRA10EV3	ELVX12S18E6V + ERRA12EV3	ELVX12S23E6V + ERRA12EV3	
Space heating 	Cold climate water outlet 55°C	Tol (tem- perature operating limit)	Pdh	kW	4.9		6.1		7.2		
			PERd	%	57.4		59.7		61.7		
		G Condition (-15°CDB/-)	TOL	°C				-22			
			WTOL	°C				55			
		Tbiv (bivalent tempera- ture)	COPd			1.93			1.96		
			Pdh	kW		6.0			7.2		
			PERd	%		77.2			78.4		
		Rated heat output sup- plementary capacity	COPd			2.17			1.96		
			Pdh	kW		6.6			7.2		
			PERd	%		86.9			78.4		
	Warm climate water outlet 55°C	General	Tbiv	°C		-12		-15			
			Psup (at Tdesign -22°C)	kW	4.1		2.9		1.8		
			Annual energy consumption	kWh			2,946				
			ηs (Seasonal space heating efficiency)	%			171				
		B Condition (2°CDB- B/1°CWB)	Prated at 2°C	kW			9.6				
			Qhe Annual energy consumption (GCV)	Gj			11				
			Cdh (Degradation heating)				1.0				
		C Condition (7°CDB- B/6°CWB)	COPd				2.57				
			Pdh	kW			8.0				
			PERd	%			102.6				
D Condition (12°CDB- B/11°CWB)	Cdh (Degradation heating)				1.0						
	COPd				3.65						
	Pdh	kW			6.7						
Average climate water outlet 35°C	General	PERd	%		146.2						
		Cdh (Degradation heating)			1.0						
		COPd				5.71					
		Pdh	kW			3.6					
		PERd	%			228.3					
Average climate water outlet 35°C	General	Tbiv	°C		3.02		4				
		COPd				3.02					
		Pdh	kW			8.4					
		PERd	%			120.9					
		Tbiv	°C			4					
Average climate water outlet 35°C	General	Annual energy consumption	kWh	3,582		3,560					
		ηs (Seasonal space heating efficiency)	%	188		190					
		Prated at -10°C	kW			8.3					
		Qhe Annual energy consumption (GCV)	Gj			13					
		SCOP			4.79		4.82				

## 2 Specifications

### 2 - 1 Specifications



2



Technical specifications				ELVX12S18E6V + ERRA08EV3	ELVX12S23E6V + ERRA08EV3	ELVX12S18E6V + ERRA10EV3	ELVX12S23E6V + ERRA10EV3	ELVX12S18E6V + ERRA12EV3	ELVX12S23E6V + ERRA12EV3		
Space heating Average climate water outlet 35°C	General	Seasonal space heating eff. class		A+++							
	A Condition	COPd		3.10							
	B/-8°CWB)	Pdh	kW		7.5						
		PERd	%		124.1						
		B Condition	Cdh (Degradation heating)		1.0						
	(2°C- B/1°CWB)	COPd			4.76						
		Pdh	kW		4.4						
		PERd	%		190.4						
	C Condition	Cdh (Degradation heating)			1.0						
		(7°C- B/6°CWB)	COPd		6.14						
		Pdh	kW		4.3						
	D Condition	PERd	%		245.8						
		Cdh (Degradation heating)			1.0						
		(12°C- B/11°CWB)	COPd		7.84						
	Tol (tem- perature operating limit)	Pdh	kW		6.6						
		PERd	%		313.4						
		TOL	°C		-10						
	Tbiv (bivalent tempera- ture)	WTOL	°C		35						
		COPd		2.80					2.77		
		Pdh	kW	6.9					8.1		
	Rated heat output sup- plementary capacity	PERd	%	112.2					110.8		
		Tbiv	°C		-10						
		PERd	%		35						
	Cold climate water outlet 35°C	General	COPd		3.10					2.77	
Pdh			kW	7.5					8.1		
PERd			%	124.1					110.8		
Tbiv			°C	-7					-10		
A Condition		Psup (at Tdesign -10°C)	kW	1.4					0.0		
		Annual energy consumption	kWh	5,507					5,355	5,340	
			ηs (Seasonal space heating efficiency)	%	158					163	
			Prated at -22°C	kW		9					
		B Condition	Qhe Annual energy consumption (GCV)	Gj	19.8					19.3	19.2
			(2°C- B/1°CWB)	COPd		3.36					
Pdh	kW			5.4							
B Condition	PERd	%		134.5							
	Cdh (Degradation heating)			1.0							
	(2°C- B/1°CWB)	COPd		5.21							
B Condition	Pdh	kW		3.6							
	PERd	%		208.4							

# 2 Specifications

## 2 - 1 Specifications

Technical specifications				ELVX12S18E6V + ERRA08EV3	ELVX12S23E6V + ERRA08EV3	ELVX12S18E6V + ERRA10EV3	ELVX12S23E6V + ERRA10EV3	ELVX12S18E6V + ERRA12EV3	ELVX12S23E6V + ERRA12EV3
Space heating 	Cold climate water outlet 35°C	C Condition (7°CDB- B/6°CWB)	Cdh (Degradation heating)	1.0					
			COPd	6.29					
			Pdh kW	5.3					
			PERd %	251.7					
		D Condition (12°CDB- B/11°CWB)	Cdh (Degradation heating)	1.0					
			COPd	7.69					
			Pdh kW	6.6					
			PERd %	307.6					
		Tol (tem- perature operating limit)	COPd	2.04		2.07		2.09	
			Pdh kW	4.9		5.9		6.4	
			PERd %	81.6		82.9		83.6	
			TOL °C			-22			
	G Condition (-15°CDB/-)	COPd	2.60			2.56			
		Pdh kW	6.0			7.0			
		PERd %	103.8			102.6			
		Tbiv COPd	2.86			2.56			
	Tbiv (bivalent tempera- ture)	Pdh kW	6.5			7.0			
		PERd %	114.4			102.6			
		Tbiv °C	-12			-15			
		Rated heat output sup- plementary capacity	Psup (at Tdesign -22°C) kW	4.1		3.1		2.6	
	Warm climate water outlet 35°C	General	Annual energy consumption	1,934					
			ηs (Seasonal space heating efficiency)	235					
			Prated at 2°C	8.6					
			Qhe Annual energy consumption (GCV)	7					
B Condition (2°CDB- B/1°CWB)		Cdh (Degradation heating)	1.0						
		COPd	4.06						
		Pdh kW	6.8						
		PERd %	162.4						
C Condition (7°CDB- B/6°CWB)		Cdh (Degradation heating)	1.0						
		COPd	5.65						
		Pdh kW	5.5						
		PERd %	226.0						
Tbiv (bivalent tempera- ture)	COPd	4.73							
	Pdh kW	6.8							
	PERd %	189.2							
	Tbiv °C	5							
Space heating 	Warm climate water outlet 35°C	D Condition (12°CDB- B/11°CWB)	Cdh (Degradation heating)	1.0					
			COPd	7.52					
			Pdh kW	6.1					
			PERd %	300.8					

(1)Capacity according to standard EN14511 and valid for heated water range dT = 3~8°C at Ta 7°C |  
 (2)Condition: Ta DB/WB 7°C/6°C - LWC 35°C (DT = 5°C) |  
 (3)Cooling: EW 12°C; LW 7°C; ambient conditions: 35°CDB |  
 (4)Cooling: EW 23°C; LW 18°C; ambient conditions: 35°CDB |  
 (5)Power input is total input of indoor and outdoor units, including the circulation pump; according to EN14511 |  
 (6)Test at Ta DB/WB 7°C/6°C. According to EN 16147. |  
 (7)DB/WB 7°C/6°C - LWC 35°C (dT=5°C) with pump at full speed

Technical specifications				ELVX12S18E9W + ERRA08EV3	ELVX12S23E9W + ERRA08EV3	ELVX12S18E9W + ERRA10EV3	ELVX12S23E9W + ERRA10EV3	ELVX12S18E9W + ERRA12EV3	ELVX12S23E9W + ERRA12EV3	
Heating capacity	Min.		kW	3.45 (1)						
	Nom.		kW	6.17 (2)						
	Max.		kW	7.95 (1)		9.25 (1)		9.97 (1)		
Cooling capacity	Nom.		kW	6.81 (3) / 6.47 (4)		7.97 (3) / 6.47 (4)		8.62 (3) / 6.47 (4)		
Power input	Heating	Min.	kW	0.72 (5)						
		Nom.	kW	1.25 (2)						
		Max.	kW	1.69 (5)		2.04 (5)		2.28 (5)		
	Cooling	Nom.	kW	2.15 (3) / 1.16 (4)		2.66 (3) / 1.16 (4)		2.96 (3) / 1.16 (4)		
		Domestic hot water from 10°C to 50°C	Nom.	kWh	2.63 (6)	3.19 (6)	2.63 (6)	3.19 (6)	2.63 (6)	3.19 (6)
		Heat up time from 10°C to 50°C		hr	1h 51min	2h 10min	1h 51min	2h 10min	1h 51min	2h 10min
COP			4.92 (2)							
EER			3.17 (3) / 5.56 (4)		3.00 (3) / 5.56 (4)		2.91 (3) / 5.56 (4)			

## 2 Specifications

### 2 - 1 Specifications

2

Technical specifications				ELVX12S18E9W + ERRA08EV3	ELVX12S23E9W + ERRA08EV3	ELVX12S18E9W + ERRA10EV3	ELVX12S23E9W + ERRA10EV3	ELVX12S18E9W + ERRA12EV3	ELVX12S23E9W + ERRA12EV3		
Pump	Type	Grundfos UPM4L K 15-75 130 9 DK1									
	Nominal ESP Heating unit	kPa	67.1 (7)								
Water side Heat exchanger	Water flow rate	Heating Nom.	l/min	18.3							
General	Supplier/Manufacturer details	Name and address		Daikin Europe N.V. - Zandvoordestraat 300, 8400 Oostende, Belgium							
		Name or trademark		Daikin Europe N.V.							
	Product description	Air-to-water heat pump			Yes						
		Brine-to-water heat pump			No						
		Heat pump combination heater			Yes						
		Low-temperature heat pump			No						
		Supplementary heater integrated			Yes						
Water-to-water heat pump			No								
LW(A) Sound power level (according to EN14825)	Indoor		dB(A)	44.0							
LW(A) Sound power level (according to EN14825)	Outdoor		dB(A)	56.0							
Sound condition Ecodesign and energy label				Sound power in heating mode, measured according to the EN12102 under conditions of the EN14825							
Tank	Name			Stainless steel domestic hot water tank 180 l	Stainless steel domestic hot water tank 230 L	Stainless steel domestic hot water tank 180 l	Stainless steel domestic hot water tank 230 L	Stainless steel domestic hot water tank 180 l	Stainless steel domestic hot water tank 230 L		
		Space heating general	Air to water unit	Rated airflow (outdoor)	m <sup>3</sup> /h	3,542					
		Other	Capacity control			Inverter					
			Pck (Crankcase heater mode)		kW	0.000					
			Poff (Off mode)		kW	0.021					
			Psb (Standby mode)		kW	0.021					
Pto (Thermostat off)		kW	0.024								
Domestic hot water heating	General	Declared load profile		L							
Space heating general	Integrated supplementary heater	Psup	kW	9.0							
		Type of energy input		Electrical							
Domestic hot water heating	Average climate	AEC (Annual electricity consumption)	kWh	877	810	877	810	877	810		
		COPdhw		2.72	2.96	2.72	2.96	2.72	2.96		
	Heat up time			1h 57min	2h 14min	1h 57min	2h 14min	1h 57min	2h 14min		
		η <sub>wh</sub> (water heating efficiency)	%	117	126	117	126	117	126		
	Qelec (Daily electricity consumption)	kWh	4.280	3.940	4.280	3.940	4.280	3.940			
	Reference hot water temperature	°C	53.0	52.0	53.0	52.0	53.0	52.0			
	Stand-by power input	W	51.7	44.8	51.7	44.8	51.7	44.8			
	Water heating energy efficiency class		A+								
	Cold climate	AEC (Annual electricity consumption)	kWh	966	891	966	891	966	891		
		COPdhw		2.48	2.70	2.48	2.70	2.48	2.70		
		Heat up time			1h 55min	2h 02min	1h 55min	2h 02min	1h 55min	2h 02min	
			η <sub>wh</sub> (water heating efficiency)	%	106	115	106	115	106	115	
		Qelec (Daily electricity consumption)	kWh	4.700	4.320	4.700	4.320	4.700	4.320		
		Reference hot water temperature	°C	53.0	52.0	53.0	52.0	53.0	52.0		
	Stand-by power input	W	55.4	47.7	55.4	47.7	55.4	47.7			
	Warm climate	AEC (Annual electricity consumption)	kWh	719	666	719	666	719	666		
		COPdhw		3.31	3.59	3.31	3.59	3.31	3.59		
Heat up time				1h 54min	2h 06min	1h 54min	2h 06min	1h 54min	2h 06min		
		η <sub>wh</sub> (water heating efficiency)	%	142	154	142	154	142	154		
Qelec (Daily electricity consumption)		kWh	3.530	3.250	3.530	3.250	3.530	3.250			
Reference hot water temperature		°C	53.0	52.0	53.0	52.0	53.0	52.0			
Stand-by power input	W	45.4	39.7	45.4	39.7	45.4	39.7				

## 2 Specifications

### 2 - 1 Specifications

Technical specifications				ELVX12S18E9W + ERRA08EV3	ELVX12S23E9W + ERRA08EV3	ELVX12S18E9W + ERRA10EV3	ELVX12S23E9W + ERRA10EV3	ELVX12S18E9W + ERRA12EV3	ELVX12S23E9W + ERRA12EV3		
Space heating Average climate water outlet 55°C	General	Annual energy consumption	kWh	7,664		7,645		7,433			
		ηs (Seasonal space heating efficiency)	%		132				136		
		Prated at -10°C	kW				12.5				
		Qhe Annual energy consumption (GCV)	Gj		28				27		
		SCOP			3.37		3.38		3.47		
		Seasonal space heating eff. class					A++				
		A Condition (-7°CDB/8°CWB)	Cdh (Degradation heating)				1.0				
			COPd				2.26				
			Pdh	kW			7.6				
			PERd	%			90.4				
		B Condition (2°CDB/11°CWB)	Cdh (Degradation heating)				1.0				
			COPd				3.39				
			Pdh	kW			6.8				
			PERd	%			135.6				
		C Condition (7°CDB/6°CWB)	Cdh (Degradation heating)				1.0				
			COPd				4.90				
			Pdh	kW			4.5				
			PERd	%			196.0				
		Space heating Average climate water outlet 55°C	General	D Condition (12°CDB/11°CWB)	Cdh (Degradation heating)					1.0	
					COPd						6.02
	Pdh			kW					5.2		
	PERd			%					240.8		
	Tol (temperature operating limit)			COPd		1.97			2.00		
				Pdh	kW	6.9			8.2		
				PERd	%	78.8			80.0		
				TOL	°C				-10		
				WTOL	°C				55		
	Rated heat output supplementary capacity			Psup (at Tdesign -10°C)	kW	5.6			4.3		
	Tbiv (bivalent temperature)			COPd			2.81			2.41	
				Pdh	kW		8.5			10.0	
				PERd	%		112.4			96.4	
				Tbiv	°C		-2			-5	
Cold climate water outlet 55°C	General			Annual energy consumption	kWh	7,257		7,127		7,100	
				ηs (Seasonal space heating efficiency)	%	119			122		
				Prated at -22°C	kW				9.0		
				Qhe Annual energy consumption (GCV)	Gj				26		
				A Condition (-7°CDB/8°CWB)	Cdh (Degradation heating)				1.0		
					COPd				2.52		
			Pdh	kW			5.2				
			PERd	%			100.6				
		B Condition (2°CDB/11°CWB)	Cdh (Degradation heating)				1.0				
			COPd				3.77				
			Pdh	kW			3.3				
			PERd	%			151.0				
		C Condition (7°CDB/6°CWB)	Cdh (Degradation heating)				1.0				
			COPd				4.81				
			Pdh	kW			3.4				
			PERd	%			192.2				
		D Condition (12°CDB/11°CWB)	COPd				6.36				
			Pdh	kW			4.2				
			PERd	%			254.2				
			Tol (temperature operating limit)	COPd		1.43		1.49		1.54	

## 2 Specifications

### 2 - 1 Specifications

2



Technical specifications				ELVX12S18E9W + ERRA08EV3	ELVX12S23E9W + ERRA08EV3	ELVX12S18E9W + ERRA10EV3	ELVX12S23E9W + ERRA10EV3	ELVX12S18E9W + ERRA12EV3	ELVX12S23E9W + ERRA12EV3	
Space heating Cold climate water outlet 55°C	Tol (tem- perature operating limit)	Pdh	kW	4.9		6.1		7.2		
		PERd	%	57.4		59.7		61.7		
		TOL	°C			-22				
		WTOL	°C			55				
	G Condition (-15°CDB/-)	COPd			1.93			1.96		
		Pdh	kW		6.0			7.2		
		PERd	%		77.2			78.4		
	Tbiv (bivalent tempera- ture)	COPd			2.17			1.96		
		Pdh	kW		6.6			7.2		
		PERd	%		86.9			78.4		
	Rated heat output sup- plementary capacity	Psup (at Tdesign -22°C)	kW		4.1		2.9		1.8	
	Warm climate water outlet 55°C	General	Annual energy consumption	kWh			2,946			
			ηs (Seasonal space heating efficiency)	%			171			
Prated at 2°C			kW			9.6				
Qhe Annual energy consumption (GCV)			Gj			11				
B Condition (2°CDB- B/1°CWB)		Cdh (Degradation heating)				1.0				
		COPd				2.57				
		Pdh	kW			8.0				
C Condition (7°CDB- B/6°CWB)		Cdh (Degradation heating)				1.0				
		COPd				3.65				
		Pdh	kW			6.7				
D Condition (12°CDB- B/11°CWB)		Cdh (Degradation heating)				1.0				
		COPd				5.71				
		Pdh	kW			3.6				
Tbiv (bivalent tempera- ture)		Cdh (Degradation heating)				228.3				
	COPd				3.02					
	Pdh	kW			8.4					
	PERd	%			120.9					
Average climate water outlet 35°C	General	Tbiv	°C			4				
		Annual energy consumption	kWh	3,582			3,560			
		ηs (Seasonal space heating efficiency)	%	188			190			
		Prated at -10°C	kW			8.3				
		Qhe Annual energy consumption (GCV)	Gj			13				
	SCOP			4.79			4.82			

## 2 Specifications



### 2 - 1 Specifications

Technical specifications				ELVX12S18E9W + ERRA08EV3	ELVX12S23E9W + ERRA08EV3	ELVX12S18E9W + ERRA10EV3	ELVX12S23E9W + ERRA10EV3	ELVX12S18E9W + ERRA12EV3	ELVX12S23E9W + ERRA12EV3	
Space heating 	Average climate water outlet 35°C	General	Seasonal space heating eff. class	A+++						
		A Condition	COPd	3.10						
		(-7°CDB/-8°CWB)	Pdh	kW	7.5					
			PERd	%	124.1					
		B Condition (2°CDB/1°CWB)	Cdh (Degradation heating)		1.0					
			COPd		4.76					
			Pdh	kW	4.4					
			PERd	%	190.4					
			C Condition (7°CDB/6°CWB)	Cdh (Degradation heating)		1.0				
		COPd			6.14					
		Pdh		kW	4.3					
			PERd	%	245.8					
			D Condition (12°CDB/11°CWB)	Cdh (Degradation heating)		1.0				
		COPd			7.84					
		Pdh		kW	6.6					
			PERd	%	313.4					
			Tol (temperature operating limit)	COPd		2.80				2.77
		Pdh		kW	6.9				8.1	
		PERd		%	112.2				110.8	
			TOL	°C	-10					
			WTOL	°C	35					
		Tbiv (bivalent temperature)	COPd		3.10				2.77	
			Pdh	kW	7.5				8.1	
			PERd	%	124.1				110.8	
			Tbiv	°C	-7					
			Rated heat output supplementary capacity	Psup (at Tdesign -10°C)	kW	1.4				
		Cold climate water outlet 35°C	General	Annual energy consumption	kWh	5,507		5,355		5,340
ηs (Seasonal space heating efficiency)	%			158				163		
Prated at -22°C	kW			9						
Qhe Annual energy consumption (GCV)	Gj			19.8		19.3		19.2		
A Condition (-7°CDB/-8°CWB)	COPd			3.36						
	Pdh		kW	5.4						
	PERd		%	134.5						
	B Condition (2°CDB/1°CWB)		Cdh (Degradation heating)		1.0					
			COPd		5.21					
Pdh	kW		3.6							
PERd	%	208.4								

# 2 Specifications

## 2 - 1 Specifications

2

Technical specifications				ELVX12S18E9W + ERRA08EV3	ELVX12S23E9W + ERRA08EV3	ELVX12S18E9W + ERRA10EV3	ELVX12S23E9W + ERRA10EV3	ELVX12S18E9W + ERRA12EV3	ELVX12S23E9W + ERRA12EV3
Space heating 	Cold climate water outlet 35°C	C Condition (7°CDB- B/6°CWB)	Cdh (Degradation heating)	1.0					
			COPd	6.29					
			Pdh kW	5.3					
		PERd %	251.7						
		D Condition (12°CDB- B/11°CWB)	Cdh (Degradation heating)	1.0					
			COPd	7.69					
	Pdh kW		6.6						
	Tol (tem- perature operating limit)		COPd	2.04		2.07		2.09	
			Pdh kW	4.9		5.9		6.4	
			PERd %	81.6		82.9		83.6	
			TOL °C	-22					
			WTOL °C	35					
	G Condition (-15°CDB/-)		COPd	2.60		2.56			
			Pdh kW	6.0		7.0			
			PERd %	103.8		102.6			
	Tbiv (bivalent tempera- ture)		COPd	2.86		2.56			
			Pdh kW	6.5		7.0			
			PERd %	114.4		102.6			
			Tbiv °C	-12		-15			
	Rated heat output sup- plementary capacity		Psup (at Tdesign -22°C) kW	4.1		3.1		2.6	
	Warm climate water outlet 35°C	General	Annual energy consumption	1,934					
			ηs (Seasonal space heating efficiency)	235					
			Prated at 2°C	8.6					
Qhe Annual energy consumption (GCV)			7						
B Condition (2°CDB- B/1°CWB)			Cdh (Degradation heating)	1.0					
			COPd	4.06					
			Pdh kW	6.8					
			PERd %	162.4					
C Condition (7°CDB- B/6°CWB)			Cdh (Degradation heating)	1.0					
			COPd	5.65					
			Pdh kW	5.5					
			PERd %	226.0					
Tbiv (bivalent tempera- ture)		COPd	4.73						
		Pdh kW	6.8						
		PERd %	189.2						
		Tbiv °C	5						
Space heating 	Warm climate water outlet 35°C	D Condition (12°CDB- B/11°CWB)	Cdh (Degradation heating)	1.0					
			COPd	7.52					
			Pdh kW	6.1					
			PERd %	300.8					

(1)Capacity according to standard EN14511 and valid for heated water range dT = 3~8°C at Ta 7°C |  
 (2)Condition: Ta DB/WB 7°C/6°C - LWC 35°C (DT = 5°C) |  
 (3)Cooling: EW 12°C; LW 7°C; ambient conditions: 35°CDB |  
 (4)Cooling: EW 23°C; LW 18°C; ambient conditions: 35°CDB |  
 (5)Power input is total input of indoor and outdoor units, including the circulation pump; according to EN14511 |  
 (6)Test at Ta DB/WB 7°C/6°C. According to EN 16147. |  
 (7)DB/WB 7°C/6°C - LWC 35°C (dT=5°C) with pump at full speed

Technical specifications				ELVZ12S18E6V + ERRA08EV3	ELVZ12S23E6V + ERRA08EV3	ELVZ12S18E6V + ERRA10EV3	ELVZ12S23E6V + ERRA10EV3	ELVZ12S18E6V + ERRA12EV3	ELVZ12S23E6V + ERRA12EV3
Heating capacity	Min.	kW	3.45 (1)						
	Nom.	kW	6.17 (2)						
	Max.	kW	7.95 (1)		9.25 (1)		9.97 (1)		
Power input	Heating	Min.	0.72 (3)						
		Nom.	1.25 (2)						
		Max.	2.04 (3)						
	Domestic hot water from 10°C to 50°C	Nom.	2.63 (4)	3.19 (4)	2.63 (4)	3.19 (4)	2.63 (4)	3.19 (4)	
Heat up time from 10°C to 50°C	hr	1h 51min	2h 10min	1h 51min	2h 10min	1h 51min	2h 10min		
COP		4.92 (2)							
Pump	Type	Grundfos UPMAL K 15-75 130 9 DKI							
Pump Additional Zone	Nominal ESP Heating unit	kPa	61.4 (5)						

## 2 Specifications

### 2 - 1 Specifications

Technical specifications				ELVZ12S18E6V + ERRA08EV3	ELVZ12S23E6V + ERRA08EV3	ELVZ12S18E6V + ERRA10EV3	ELVZ12S23E6V + ERRA10EV3	ELVZ12S18E6V + ERRA12EV3	ELVZ12S23E6V + ERRA12EV3
Pump Main Zone	Nominal ESP unit	Heating	kPa	59.5 (5)					
Water side Heat exchanger	Water flow rate	Heating Nom.	l/min	18.3					
General	Supplier/Manufacturer details	Name and address	Daikin Europe N.V. - Zandvoordestraat 300, 8400 Oostende, Belgium						
		Name or trademark	Daikin Europe N.V.						
	Product description	Air-to-water heat pump	Yes						
		Brine-to-water heat pump	No						
		Heat pump combination heater	Yes						
		Low-temperature heat pump	No						
		Supplementary heater integrated	Yes						
Water-to-water heat pump	No								
LW(A) Sound power level (according to EN14825)	Indoor		dB(A)	44.0					
LW(A) Sound power level (according to EN14825)	Outdoor		dB(A)	56.0					
Sound condition Ecodesign and energy label				Sound power in heating mode, measured according to the EN12102 under conditions of the EN14825					
Tank	Name			Stainless steel domestic hot water tank 180 l	Stainless steel domestic hot water tank 230 L	Stainless steel domestic hot water tank 180 l	Stainless steel domestic hot water tank 230 L	Stainless steel domestic hot water tank 180 l	Stainless steel domestic hot water tank 230 L
Space heating general	Air to water unit	Rated airflow (outdoor)	m <sup>3</sup> /h	3,542					
	Other	Capacity control		Inverter					
		Pck (Crankcase heater mode)	kW	0.000					
		Poff (Off mode)	kW	0.021					
		Psb (Standby mode)	kW	0.021					
		Pto (Thermostat off)	kW	0.024					
Domestic hot water heating	General	Declared load profile		L					
Space heating general	Integrated supplementary heater	Psup	kW	6.0					
		Type of energy input		Electrical					
Domestic hot water heating	Average climate	AEC (Annual electricity consumption)	kWh	877	810	877	810	877	810
		COPdhw		2.72	2.96	2.72	2.96	2.72	2.96
Domestic hot water heating	Average climate	Heat up time		1h 57min	2h 14min	1h 57min	2h 14min	1h 57min	2h 14min
		η <sub>wh</sub> (water heating efficiency)	%	117	126	117	126	117	126
		Qelec (Daily electricity consumption)	kWh	4.280	3.940	4.280	3.940	4.280	3.940
		Reference hot water temperature	°C	53.0	52.0	53.0	52.0	53.0	52.0
		Stand-by power input	W	51.7	44.8	51.7	44.8	51.7	44.8
		Water heating energy efficiency class		A+					
	Cold climate	AEC (Annual electricity consumption)	kWh	966	891	966	891	966	891
		COPdhw		2.48	2.70	2.48	2.70	2.48	2.70
		Heat up time		1h 55min	2h 02min	1h 55min	2h 02min	1h 55min	2h 02min
		η <sub>wh</sub> (water heating efficiency)	%	106	115	106	115	106	115
		Qelec (Daily electricity consumption)	kWh	4.700	4.320	4.700	4.320	4.700	4.320
		Reference hot water temperature	°C	53.0	52.0	53.0	52.0	53.0	52.0
	Warm climate	Stand-by power input	W	55.4	47.7	55.4	47.7	55.4	47.7
AEC (Annual electricity consumption)		kWh	719	666	719	666	719	666	
COPdhw			3.31	3.59	3.31	3.59	3.31	3.59	
Heat up time			1h 54min	2h 06min	1h 54min	2h 06min	1h 54min	2h 06min	
η <sub>wh</sub> (water heating efficiency)		%	142	154	142	154	142	154	
Qelec (Daily electricity consumption)		kWh	3.530	3.250	3.530	3.250	3.530	3.250	
Reference hot water temperature		°C	53.0	52.0	53.0	52.0	53.0	52.0	
Stand-by power input	W	45.4	39.7	45.4	39.7	45.4	39.7		

## 2 Specifications

### 2 - 1 Specifications

Technical specifications				ELVZ12S18E6V + ERRA08EV3	ELVZ12S23E6V + ERRA08EV3	ELVZ12S18E6V + ERRA10EV3	ELVZ12S23E6V + ERRA10EV3	ELVZ12S18E6V + ERRA12EV3	ELVZ12S23E6V + ERRA12EV3			
Space heating	Average climate water outlet 55°C	General	Annual energy consumption	kWh	7,742		7,723		7,510			
			ηs (Seasonal space heating efficiency)	%	130		131		135			
			Prated at -10°C	kW			12.5					
			Qhe Annual energy consumption (GCV)	Gj		28			27			
			SCOP			3.34			3.44			
			Seasonal space heating eff. class				A++					
			A Condition (-7°C-D- B/-8°CWB)	Cdh (Degradation heating)				1.0				
				COPd				2.26				
				Pdh	kW			7.6				
				PERd	%			90.4				
			B Condition (2°C-D- B/1°CWB)	Cdh (Degradation heating)				1.0				
				COPd				3.39				
				Pdh	kW			6.8				
				PERd	%			135.6				
			C Condition (7°C-D- B/6°CWB)	Cdh (Degradation heating)				1.0				
				COPd				4.90				
				Pdh	kW			4.5				
				PERd	%			196.0				
			Space heating	Average climate water outlet 55°C	General	D Condition (12°C-D- B/11°CWB)	Cdh (Degradation heating)				1.0	
							COPd				6.02	
	Pdh	kW						5.2				
	PERd	%						240.8				
Tol (temperature operating limit)	COPd					1.97			2.00			
	Pdh	kW				6.9			8.2			
	PERd	%				78.8			80.0			
	TOL	°C							-10			
	WTOL	°C							55			
Rated heat output supplementary capacity	Psup (at Tdesign -10°C)	kW				5.6			4.3			
Tbiv (bivalent temperature)	COPd						2.81		2.41			
	Pdh	kW					8.5		10.0			
	PERd	%					112.4		96.4			
	Tbiv	°C					-2		-5			
Cold climate water outlet 55°C	General	Annual energy consumption				Annual energy consumption	kWh	7,303		7,173		7,146
						ηs (Seasonal space heating efficiency)	%	118			121	
						Prated at -22°C	kW			9.0		
						Qhe Annual energy consumption (GCV)	Gj			26		
						A Condition (-7°C-D- B/-8°CWB)	Cdh (Degradation heating)				1.0	
							COPd				2.52	
				Pdh	kW			5.2				
				PERd	%			100.6				
			B Condition (2°C-D- B/1°CWB)	Cdh (Degradation heating)				1.0				
				COPd				3.77				
				Pdh	kW			3.3				
				PERd	%			151.0				
			C Condition (7°C-D- B/6°CWB)	Cdh (Degradation heating)				1.0				
				COPd				4.81				
				Pdh	kW			3.4				
				PERd	%			192.2				
			D Condition (12°C-D- B/11°CWB)	COPd				6.36				
				Pdh	kW			4.2				
				PERd	%			254.2				
			Tol (temperature operating limit)	COPd		1.43		1.49		1.54		
	Pdh	kW	4.9		6.1		7.2					
	PERd	%	57.4		59.7		61.7					

## 2 Specifications

### 2 - 1 Specifications

Technical specifications				ELVZ12S18E6V + ERRA08EV3	ELVZ12S23E6V + ERRA08EV3	ELVZ12S18E6V + ERRA10EV3	ELVZ12S23E6V + ERRA10EV3	ELVZ12S18E6V + ERRA12EV3	ELVZ12S23E6V + ERRA12EV3	
Space heating 	Cold climate water outlet 55°C	Tol (tem- perature operating limit)	TOL °C				-22			
			WTOL °C				55			
	G Condition (-15°CDB/-)	COPd			1.93			1.96		
			Pdh	kW	6.0			7.2		
			PERd	%	77.2			78.4		
	Tbiv (bivalent tempera- ture)	COPd			2.17			1.96		
			Pdh	kW	6.6			7.2		
			PERd	%	86.9			78.4		
	Rated heat output sup- plementary capacity	Psup (at Tdesign -22°C)		kW	4.1		2.9	-15		1.8
	Warm climate water outlet 55°C	General	Annual energy consumption	kWh				3,039		
			ηs (Seasonal space heating efficiency)	%				166		
			Prated at 2°C	kW				9.6		
			Qhe Annual energy consumption (GCV)	Gj				11		
B Condition (2°CDB- B/1°CWB)		COPd	Cdh (Degradation heating)					1.0		
								2.57		
			Pdh	kW				8.0		
			PERd	%				102.6		
C Condition (7°CDB- B/6°CWB)		COPd	Cdh (Degradation heating)					1.0		
								3.65		
			Pdh	kW				6.7		
			PERd	%				146.2		
D Condition (12°CDB- B/11°CWB)		COPd	Cdh (Degradation heating)					1.0		
								5.71		
			Pdh	kW				3.6		
	PERd		%				228.3			
Tbiv (bivalent tempera- ture)	COPd						3.02			
							8.4			
		Pdh	kW				120.9			
		PERd	%				4			
Average climate water outlet 35°C	General	Annual energy consumption	kWh	3,659			3,637			
		ηs (Seasonal space heating efficiency)	%	184			186			
		Prated at -10°C	kW				8.3			
		Qhe Annual energy consumption (GCV)	Gj				13			
		SCOP		4.69			4.71			
	Seasonal space heating eff. class					A+++				
	A Condition (-7°CDB- B/-8°CWB)	COPd					3.10			

## 2 Specifications



### 2 - 1 Specifications

2

Technical specifications				ELVZ12S18E6V + ERRA08EV3	ELVZ12S23E6V + ERRA08EV3	ELVZ12S18E6V + ERRA10EV3	ELVZ12S23E6V + ERRA10EV3	ELVZ12S18E6V + ERRA12EV3	ELVZ12S23E6V + ERRA12EV3	
Space heating Average climate water outlet 35°C	A Condition (-7°CDB/-8°CWB)	Pdh	kW					7.5		
		PERd	%					124.1		
	B Condition (2°CDB/1°CWB)	Cdh (Degradation heating)							1.0	
		COPd							4.76	
		Pdh	kW						4.4	
		PERd	%					190.4		
	C Condition (7°CDB/6°CWB)	Cdh (Degradation heating)							1.0	
		COPd							6.14	
		Pdh	kW						4.3	
		PERd	%					245.8		
	D Condition (12°CDB/11°CWB)	Cdh (Degradation heating)							1.0	
		COPd							7.84	
		Pdh	kW						6.6	
		PERd	%					313.4		
	Tol (temperature operating limit)	COPd			2.80				2.77	
		Pdh	kW		6.9				8.1	
		PERd	%		112.2				110.8	
		TOL	°C						-10	
		WTOL	°C						35	
	Tbiv (bivalent temperature)	COPd			3.10				2.77	
Pdh		kW		7.5				8.1		
PERd		%		124.1				110.8		
Tbiv		°C		-7				-10		
Rated heat output supplementary capacity	Psup (at Tdesign -10°C)		kW	1.4				0.0		
Cold climate water outlet 35°C	General	Annual energy consumption	kWh	5,554			5,401		5,387	
		ηs (Seasonal space heating efficiency)	%	157			161		162	
	Prated at -22°C		kW				9			
	Qhe Annual energy consumption (GCV)		Gj	20.0			19.4			
A Condition (-7°CDB/-8°CWB)	COPd							3.36		
	Pdh	kW						5.4		
	PERd	%						134.5		
B Condition (2°CDB/1°CWB)	Cdh (Degradation heating)							1.0		
	COPd							5.21		
	Pdh	kW						3.6		
	PERd	%						208.4		
C Condition (7°CDB/6°CWB)	Cdh (Degradation heating)							1.0		
	COPd							6.29		

# 2 Specifications

## 2 - 1 Specifications

Technical specifications				ELVZ12S18E6V + ERRA08EV3	ELVZ12S23E6V + ERRA08EV3	ELVZ12S18E6V + ERRA10EV3	ELVZ12S23E6V + ERRA10EV3	ELVZ12S18E6V + ERRA12EV3	ELVZ12S23E6V + ERRA12EV3			
Space heating 	Cold climate water outlet 35°C	C Condition (7°CDB- B/6°CWB)	Pdh	kW						5.3		
			PERd	%						251.7		
		D Condition (12°CDB- B/11°CWB)	Cdh (Degradation heating)								1.0	
			COPd								7.69	
			Pdh	kW						6.6		
			PERd	%						307.6		
		Tol (tem- perature operating limit)	Tol (tem- perature operating limit)			2.04			2.07		2.09	
			Pdh	kW						4.9	5.9	6.4
			PERd	%						81.6	82.9	83.6
			TOL								-22	
			WTOL								35	
		G Condition (-15°CDB/-)	COPd								2.60	2.56
	Pdh		kW						6.0	7.0		
	PERd		%						103.8	102.6		
	Tbiv (bivalent tempera- ture)	COPd								2.86	2.56	
		Pdh	kW						6.5	7.0		
		PERd	%						114.4	102.6		
		Tbiv	°C						-12	-15		
	Rated heat output sup- plementary capacity	Psup (at Tdesign -22°C)								4.1	3.1	2.6
		Warm climate water outlet 35°C	General	Annual energy consumption							2,027	
	ηs (Seasonal space heating efficiency)								224			
	Prated at 2°C								8.6			
	Qhe Annual energy consumption (GCV)							7				
	B Condition (2°CDB- B/1°CWB)		Cdh (Degradation heating)								1.0	
COPd								4.06				
Pdh		kW						6.8				
PERd		%						162.4				
C Condition (7°CDB- B/6°CWB)	Cdh (Degradation heating)								1.0			
	COPd								5.65			
	Pdh	kW						5.5				
	PERd	%						226.0				
Tbiv (bivalent tempera- ture)	COPd								4.73			
	Pdh	kW						6.8				
	PERd	%						189.2				
	Tbiv	°C						5				
D Condition (12°CDB- B/11°CWB)	Cdh (Degradation heating)								1.0			
	COPd								7.52			
Space heating 	Warm climate water outlet	D Condition (12°CDB- B/11°CWB)	Pdh	kW						6.1		
			PERd	%						300.8		

(1)Capacity according to standard EN14511 and valid for heated water range dT = 3~8°C at Ta 7°C |  
 (2)Condition: Ta DB/WB 7°C/6°C - LWC 35°C. (DT = 5°C) |  
 (3)Power input is total input of indoor and outdoor units, including the circulation pump; according to EN14511 |  
 (4)Test at Ta DB/WB 7°C/6°C. According to EN 16147. |  
 (5)DB/WB 7°C/6°C - LWC 35°C (dT=5°C) with pump at full speed |  
 Cooling: EW 12°C; LW 7°C; ambient conditions: 35°CDB |  
 Cooling: EW 23°C; LW 18°C; ambient conditions: 35°CDB

Technical specifications				ELVZ12S18E9V + ERRA08EV3	ELVZ12S23E9V + ERRA08EV3	ELVZ12S18E9V + ERRA10EV3	ELVZ12S23E9V + ERRA10EV3	ELVZ12S18E9V + ERRA12EV3	ELVZ12S23E9V + ERRA12EV3	
Heating capacity	Min.								3.45 (1)	
	Nom.								6.17 (2)	
	Max.			7.95 (1)				9.97 (1)		
Power input	Heating	Min.								0.72 (3)
		Nom.								1.25 (2)
		Max.			1.69 (3)				2.04 (3)	2.28 (3)
	Domestic hot water from 10°C to 50°C	Nom.	kWh	2.63 (4)	3.19 (4)	2.63 (4)	3.19 (4)	2.63 (4)	3.19 (4)	
Heat up time from 10°C to 50°C			hr	1h 51min	2h 10min	1h 51min	2h 10min	1h 51min	2h 10min	
COP									4.92 (2)	
Pump	Type								Grundfos UPM4L K 15-75 130 9 DKI	
Pump Additional Zone	Nominal ESP Heating unit								61.4 (5)	

# 2 Specifications

## 2 - 1 Specifications

2

Technical specifications				ELVZ12S18E9W + ERRA08EV3	ELVZ12S23E9W + ERRA08EV3	ELVZ12S18E9W + ERRA10EV3	ELVZ12S23E9W + ERRA10EV3	ELVZ12S18E9W + ERRA12EV3	ELVZ12S23E9W + ERRA12EV3	
Pump Main Zone	Nominal ESP unit	Heating	kPa	59.5 (5)						
Water side Heat exchanger	Water flow rate	Heating Nom.	l/min	18.3						
General	Supplier/Manufacturer details	Name and address		Daikin Europe N.V. - Zandvoordestraat 300, 8400 Oostende, Belgium						
		Name or trademark		Daikin Europe N.V.						
	Product description	Air-to-water heat pump			Yes					
		Brine-to-water heat pump			No					
		Heat pump combination heater			Yes					
		Low-temperature heat pump			No					
		Supplementary heater integrated			Yes					
Water-to-water heat pump			No							
LW(A) Sound power level (according to EN14825)	Indoor		dB(A)	44.0						
LW(A) Sound power level (according to EN14825)	Outdoor		dB(A)	56.0						
Sound condition Ecodesign and energy label				Sound power in heating mode, measured according to the EN12102 under conditions of the EN14825						
Tank	Name			Stainless steel domestic hot water tank 180 l	Stainless steel domestic hot water tank 230 L	Stainless steel domestic hot water tank 180 l	Stainless steel domestic hot water tank 230 L	Stainless steel domestic hot water tank 180 l	Stainless steel domestic hot water tank 230 L	
Space heating general	Air to water unit	Rated airflow (outdoor)	m <sup>3</sup> /h	3,542						
	Other	Capacity control			Inverter					
		Pck (Crankcase heater mode)		kW	0.000					
		Poff (Off mode)		kW	0.021					
		Psb (Standby mode)		kW	0.021					
		Pto (Thermostat off)		kW	0.024					
Domestic hot water heating	General	Declared load profile		L						
Space heating general	Integrated supplementary heater	Psup	kW	9.0						
		Type of energy input		Electrical						
Domestic hot water heating	Average climate	AEC (Annual electricity consumption)		877	810	877	810	877	810	
		COPdhw		2.72	2.96	2.72	2.96	2.72	2.96	
Domestic hot water heating	Average climate	Heat up time		1h 57min	2h 14min	1h 57min	2h 14min	1h 57min	2h 14min	
		ηwh (water heating efficiency)		%	117	126	117	126	117	126
		Qelec (Daily electricity consumption)		kWh	4.280	3.940	4.280	3.940	4.280	3.940
		Reference hot water temperature		°C	53.0	52.0	53.0	52.0	53.0	52.0
		Stand-by power input		W	51.7	44.8	51.7	44.8	51.7	44.8
	Water heating energy efficiency class		A+							
	Cold climate	AEC (Annual electricity consumption)		kWh	966	891	966	891	966	891
		COPdhw			2.48	2.70	2.48	2.70	2.48	2.70
		Heat up time			1h 55min	2h 02min	1h 55min	2h 02min	1h 55min	2h 02min
		ηwh (water heating efficiency)		%	106	115	106	115	106	115
Qelec (Daily electricity consumption)		kWh	4.700	4.320	4.700	4.320	4.700	4.320		
Warm climate	Reference hot water temperature		°C	53.0	52.0	53.0	52.0	53.0	52.0	
	Stand-by power input		W	55.4	47.7	55.4	47.7	55.4	47.7	
	AEC (Annual electricity consumption)		kWh	719	666	719	666	719	666	
	COPdhw			3.31	3.59	3.31	3.59	3.31	3.59	
	Heat up time			1h 54min	2h 06min	1h 54min	2h 06min	1h 54min	2h 06min	
	ηwh (water heating efficiency)		%	142	154	142	154	142	154	
	Qelec (Daily electricity consumption)		kWh	3.530	3.250	3.530	3.250	3.530	3.250	
	Reference hot water temperature		°C	53.0	52.0	53.0	52.0	53.0	52.0	
	Stand-by power input		W	45.4	39.7	45.4	39.7	45.4	39.7	

## 2 Specifications

### 2 - 1 Specifications

Technical specifications				ELVZ12S18E9W + ERRA08EV3	ELVZ12S23E9W + ERRA08EV3	ELVZ12S18E9W + ERRA10EV3	ELVZ12S23E9W + ERRA10EV3	ELVZ12S18E9W + ERRA12EV3	ELVZ12S23E9W + ERRA12EV3	
Space heating Average climate water outlet 55°C	General	Annual energy consumption	kWh	7,742		7,723		7,510		
		ηs (Seasonal space heating efficiency)	%	130		131		135		
		Prated at -10°C	kW			12.5				
		Qhe Annual energy consumption (GCV)	Gj		28			27		
		SCOP			3.34			3.44		
		Seasonal space heating eff. class				A++				
		A Condition (-7°C-D- B/-8°CWB)	Cdh (Degradation heating)				1.0			
			COPd				2.26			
			Pdh	kW			7.6			
			PERd	%			90.4			
		B Condition (2°C-D- B/1°CWB)	Cdh (Degradation heating)				1.0			
			COPd				3.39			
			Pdh	kW			6.8			
			PERd	%			135.6			
		C Condition (7°C-D- B/6°CWB)	Cdh (Degradation heating)				1.0			
			COPd				4.90			
			Pdh	kW			4.5			
	PERd	%			196.0					
Space heating Average climate water outlet 55°C	General	D Condition (12°C-D- B/11°CWB)	Cdh (Degradation heating)				1.0			
			COPd				6.02			
			Pdh	kW			5.2			
			PERd	%			240.8			
		Tol (temperature operating limit)	COPd		1.97			2.00		
			Pdh	kW	6.9			8.2		
			PERd	%	78.8			80.0		
			TOL	°C				-10		
			WTOL	°C				55		
		Rated heat output supplementary capacity	Psup (at Tdesign -10°C)	kW	5.6			4.3		
		Tbiv (bivalent temperature)	COPd			2.81		2.41		
			Pdh	kW		8.5		10.0		
			PERd	%		112.4		96.4		
			Tbiv	°C		-2		-5		
		Cold climate water outlet 55°C	General	Annual energy consumption	kWh	7,303		7,173		7,146
				ηs (Seasonal space heating efficiency)	%	118			121	
				Prated at -22°C	kW			9.0		
Qhe Annual energy consumption (GCV)	Gj					26				
A Condition (-7°C-D- B/-8°CWB)	Cdh (Degradation heating)						1.0			
	COPd						2.52			
	Pdh			kW			5.2			
	PERd			%			100.6			
B Condition (2°C-D- B/1°CWB)	Cdh (Degradation heating)						1.0			
	COPd						3.77			
	Pdh			kW			3.3			
	PERd			%			151.0			
C Condition (7°C-D- B/6°CWB)	Cdh (Degradation heating)						1.0			
	COPd						4.81			
	Pdh			kW			3.4			
	PERd			%			192.2			
D Condition (12°C-D- B/11°CWB)	COPd						6.36			
	Pdh	kW			4.2					
	PERd	%			254.2					
Tol (temperature operating limit)	COPd		1.43		1.49	1.54				
	Pdh	kW	4.9		6.1	7.2				
	PERd	%	57.4		59.7	61.7				

## 2 Specifications

### 2 - 1 Specifications

2

Technical specifications				ELVZ12S18E9W + ERRA08EV3	ELVZ12S23E9W + ERRA08EV3	ELVZ12S18E9W + ERRA10EV3	ELVZ12S23E9W + ERRA10EV3	ELVZ12S18E9W + ERRA12EV3	ELVZ12S23E9W + ERRA12EV3	
Space heating 	Cold climate water outlet 55°C	Tol (tem- perature operating limit)	TOL °C				-22			
			WTOL °C				55			
	G Condition (-15°CDB/-)		COPd		1.93			1.96		
			Pdh	kW	6.0			7.2		
			PERd	%	77.2			78.4		
	Tbiv (bivalent tempera- ture)		COPd		2.17			1.96		
			Pdh	kW	6.6			7.2		
			PERd	%	86.9			78.4		
	Rated heat output sup- plementary capacity		Tbiv	°C	-12			-15		
			Psup (at Tdesign -22°C)	kW	4.1		2.9		1.8	
	Warm climate water outlet 55°C	General	Annual energy consumption	kWh				3,039		
			ηs (Seasonal space heating efficiency)	%				166		
Prated at 2°C			kW				9.6			
Qhe Annual energy consumption (GCV)			Gj				11			
B Condition (2°CDB- B/1°CWB)			Cdh (Degradation heating)					1.0		
			COPd					2.57		
			Pdh	kW				8.0		
			PERd	%				102.6		
C Condition (7°CDB- B/6°CWB)			Cdh (Degradation heating)					1.0		
			COPd					3.65		
			Pdh	kW				6.7		
			PERd	%				146.2		
D Condition (12°CDB- B/11°CWB)			Cdh (Degradation heating)					1.0		
			COPd					5.71		
			Pdh	kW				3.6		
			PERd	%				228.3		
Tbiv (bivalent tempera- ture)			COPd					3.02		
			Pdh	kW				8.4		
			PERd	%				120.9		
	Tbiv		°C				4			
Average climate water outlet 35°C	General	Annual energy consumption	kWh	3,659			3,637			
		ηs (Seasonal space heating efficiency)	%	184			186			
		Prated at -10°C	kW				8.3			
		Qhe Annual energy consumption (GCV)	Gj				13			
		SCOP		4.69			4.71			
	Seasonal space heating eff. class					A+++				
	A Condition (-7°CDB- B/-8°CWB)		COPd				3.10			

## 2 Specifications



### 2 - 1 Specifications

Technical specifications				ELVZ12S18E9W + ERRA08EV3	ELVZ12S23E9W + ERRA08EV3	ELVZ12S18E9W + ERRA10EV3	ELVZ12S23E9W + ERRA10EV3	ELVZ12S18E9W + ERRA12EV3	ELVZ12S23E9W + ERRA12EV3	
Space heating 	Average climate	A Condition (-7°C-D-)	Pdh	kW					7.5	
		B/-8°CWB)	PERd	%					124.1	
	35°C water outlet	B Condition (2°C-D- B/1°CWB)	Cdh (Degradation heating)							1.0
			COPd							4.76
		Pdh	kW							4.4
		PERd	%							190.4
	C Condition (7°C-D- B/6°CWB)	Cdh (Degradation heating)								1.0
		COPd								6.14
		Pdh	kW							4.3
	D Condition (12°C-D- B/11°CWB)	Cdh (Degradation heating)								245.8
		COPd								1.0
		Pdh	kW							7.84
	Tol (temperature operating limit)	PERd	%							6.6
		TOL	°C							313.4
		WTOL	°C							
		COPd			2.80					2.77
	Tbiv (bivalent temperature)	Pdh	kW		6.9					8.1
		PERd	%		112.2					110.8
		TOL	°C							-10
		WTOL	°C							35
Rated heat output supplementary capacity	COPd			3.10					2.77	
	Pdh	kW		7.5					8.1	
	PERd	%		124.1					110.8	
	Tbiv	°C		-7					-10	
Cold climate water outlet 35°C	General	Psup (at Tdesign -10°C)	kW		1.4				0.0	
		Annual energy consumption	kWh		5,554			5,401	5,387	
		ηs (Seasonal space heating efficiency)	%		157				161	162
		Prated at -22°C	kW						9	
A Condition (-7°C-D- B/-8°CWB)	B Condition (2°C-D- B/1°CWB)	Qhe Annual energy consumption (GCV)	Gj		20.0				19.4	
		COPd							3.36	
		Pdh	kW						5.4	
	C Condition (7°C-D- B/6°CWB)	D Condition (12°C-D- B/11°CWB)	PERd	%						134.5
			Cdh (Degradation heating)							1.0
			COPd							5.21
	E Condition (17°C-D- B/11°CWB)	F Condition (22°C-D- B/11°CWB)	Pdh	kW						3.6
			PERd	%						208.4
			Cdh (Degradation heating)							1.0
	G Condition (27°C-D- B/11°CWB)	H Condition (32°C-D- B/11°CWB)	COPd							6.29

## 2 Specifications

### 2 - 1 Specifications

2

Technical specifications				ELVZ12S18E9W + ERRA08EV3	ELVZ12S23E9W + ERRA08EV3	ELVZ12S18E9W + ERRA10EV3	ELVZ12S23E9W + ERRA10EV3	ELVZ12S18E9W + ERRA12EV3	ELVZ12S23E9W + ERRA12EV3		
Space heating 	Cold climate water outlet 35°C	C Condition (7°CDB- B/6°CWB)	Pdh	kW						5.3	
			PERd	%						251.7	
		D Condition (12°CDB- B/11°CWB)	Cdh (Degradation heating)								1.0
			COPd								7.69
			Pdh	kW						6.6	
			PERd	%						307.6	
		Tol (tem- perature operating limit)	Tol (tem- perature operating limit)			2.04			2.07		2.09
			Pdh	kW	4.9			5.9		6.4	
			PERd	%	81.6			82.9		83.6	
			TOL	°C						-22	
		G Condition (-15°CDB/-)	COPd			2.60			2.56		
			Pdh	kW	6.0			7.0			
	PERd		%	103.8			102.6				
	Tbiv (bivalent tempera- ture)	COPd			2.86			2.56			
		Pdh	kW	6.5			7.0				
		PERd	%	114.4			102.6				
		Tbiv	°C	-12			-15				
	Rated heat output sup- plementary capacity	Psup (at Tdesign -22°C)			4.1		3.1		2.6		
		General								2,027	
	Warm climate water outlet 35°C	Annual energy consumption	Annual energy consumption								2,027
			ηs (Seasonal space heating efficiency)								224
			Prated at 2°C								8.6
			Qhe Annual energy consumption (GCV)								7
		B Condition (2°CDB- B/1°CWB)	Cdh (Degradation heating)								1.0
COPd								4.06			
Pdh			kW						6.8		
PERd			%						162.4		
C Condition (7°CDB- B/6°CWB)		Cdh (Degradation heating)								1.0	
		COPd								5.65	
		Pdh	kW						5.5		
		PERd	%						226.0		
Tbiv (bivalent tempera- ture)	COPd								4.73		
	Pdh	kW						6.8			
	PERd	%						189.2			
	Tbiv	°C						5			
D Condition (12°CDB- B/11°CWB)	Cdh (Degradation heating)								1.0		
	COPd								7.52		
Space heating 	Warm climate water outlet	D Condition (12°CDB- B/11°CWB)	Pdh	kW						6.1	
			PERd	%						300.8	

(1)Capacity according to standard EN14511 and valid for heated water range dT = 3~8°C at Ta 7°C |

(2)Condition: Ta DB/WB 7°C/6°C - LWC 35°C. (DT = 5°C) |

(3)Power input is total input of indoor and outdoor units, including the circulation pump; according to EN14511 |

(4)Test at Ta DB/WB 7°C/6°C. According to EN 16147. |

(5)DB/WB 7°C/6°C - LWC 35°C (dT=5°C) with pump at full speed |

Cooling: EW 12°C; LW 7°C; ambient conditions: 35°CDB |

Cooling: EW 23°C; LW 18°C; ambient conditions: 35°CDB

Technical Specifications				ERRA08EV3	ERRA10EV3	ERRA12EV3
Casing	Colour	Silver / Black				
	Material	Polyester painted galvanised steel plate				
Dimensions	Unit	Height	mm	1,003		
		Width	mm	1,270		
		Depth	mm	533		
	Packed unit	Height	mm	1,340		
		Width	mm	1,440		
		Depth	mm	690		
Weight	Unit	kg	107			
	Packed unit	kg	132			
Packing	Material	Carton / Wood (pallet) / PE (Straps) / Metal				
	Weight	kg	46			

## 2 Specifications

### 2 - 1 Specifications

Technical Specifications				ERRA08EV3	ERRA10EV3	ERRA12EV3	
Heat exchanger	Length					1,200	
	Rows	Quantity				2	
	Fin pitch					2.00	
	Passes	Quantity				10	
	Face area	m <sup>2</sup>				1.19	
	Stages	Quantity				44	
	Tube type					ø7 Hi-XSL	
	Fin	Type					WF fin
	Treatment					Anti-corrosion treatment (PE)	
Fan	Type					Propeller fan	
	Quantity					1	
	Air flow rate	Heating	Nom.	m <sup>3</sup> /min			59.0
			High	m <sup>3</sup> /min			89.9
		Cooling	Nom.	m <sup>3</sup> /min			80
			High	m <sup>3</sup> /min			80.1
Discharge direction					Horizontal		
Fan motor	Quantity					1	
	Model					Brushless DC motor	
	Output	W				183	
	Drive					Direct drive	
	Speed	Steps					6
		Heating	Nom.	rpm			390
		Cooling	Nom.	rpm			520
Compressor	Quantity					1	
Compressor	Model					2Y260BPDX1P#C	
	Type					Hermetically sealed swing compressor	
	Starting method					Inverter driven	
PED	Category					Category II	
Operation range	Heating	Min.	°CDB			-25.0	
		Max.	°CDB			25	
	Cooling	Min.	°CDB			10	
		Max.	°CDB			43	
	Domestic hot water	Max.	°CDB			35	
		Min.	°CDB			-25	
PED	Most critical part	Name				Accumulator	
		P <sub>s</sub> *V	Bar*l			109	
Sound power level	Heating	Nom.	dBA			56.0 (1)	
	Cooling	Nom.	dBA	60.1 (2)		60.6 (2) 61.5 (2)	
Sound pressure level	Heating	Nom.	dBA			40.6 (3)	
		Nom.	dBA	47.0 (4)		47.4 (4) 48.5 (4)	
	Night quiet mode	Heating	dBA			43.2 (3)	
		Cooling	dBA			43.7 (4)	
Refrigerant	Type					R-32	
	GWP					675.0	
	Charge	kg				3.25	
	Control					Expansion valve	
	Circuits	Quantity				1	
Refrigerant oil	Type					FW68DE	
	Charged volume	l				1.1	
Piping connections	Liquid	OD	mm			6.35	
		Gas	OD	mm			15.9
	Piping length	OU - IU	Min.	m			3
			Max.	m			50
	High pressure side	Design pressure				46	
	Additional refrigerant charge		kg/m		0.02 (for piping length exceeding 10m)		
	Level difference	IU - OU	Max.	m			30.0
Defrost method					Reversed cycle		
Defrost control					Sensor for outdoor heat exchanger temperature		
Capacity control	Method				Inverter controlled		
Safety devices	Item	01			High pressure switch		
		02			High pressure switch		
Safety devices	Item	03			Low pressure switch		
		04			Thermal protector for compressor		
		05			Fuse		

## 2 Specifications

### 2 - 1 Specifications

**2**

Electrical Specifications			ERRA08EV3	ERRA10EV3	ERRA12EV3	
Power supply	Name			V3		
	Phase			1~		
	Frequency	Hz		50		
	Voltage	V		230		
	Voltage range	Min.	%		-10	
		cos phi	Nom.		0.95	
			Max.		0.98	
	Max.	%		10		
Current	Minimum Ssc value	kVa	Equipment complying with EN / IEC 61000-3-12			
	Recommended fuses	A	32			
	Inverter modulation	Min. %	44	37	35	
Wiring connections	For power supply	Remark	See installation manual outdoor unit			
	For connection with indoor	Remark	See installation manual indoor unit			

(1)Cooling Ta 35°C - LWE 18°C (DT = 5°C); Heating Ta DB/WB 7°C/6°C - LWC 35°C (DT = 5°C) |

(2)Condition 2: cooling Ta 35°C - LWE 7°C ( DT = 5°C); heating Ta DB/WB 7°C/6°C - LWC 45°C ( DT = 5°C) |

(3)Sound pressure level is a relative value, depending on the distance and acoustic environment. For more details, please refer to the sound level drawings. |

(4)The sound pressure level is measured via a microphone at a certain distance from the unit. It is a relative value depending on the distance and acoustic environment. Refer to sound spectrum drawing for more information. Condition: Ta 35°C - LWE 7°C ( DT =

# 3 Capacity graphs

## 3 - 1 Cooling Capacity Graphs

ERRA08-12EV3  
ERRA08-12EW1

Maximum cooling capacity

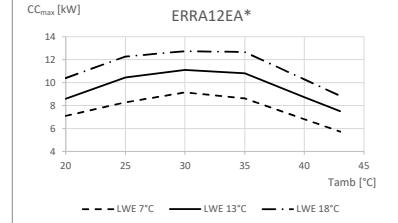
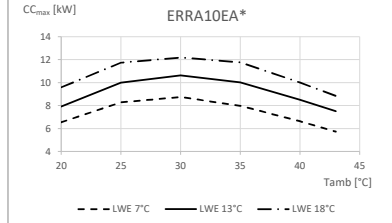
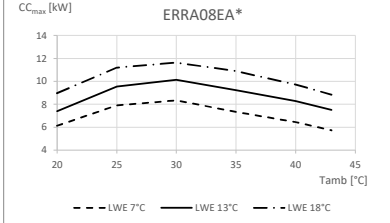

**Symbols**

- CC<sub>max</sub> Cooling capacity at maximum operating frequency, measured according to EN 14511.
- LWE Leaving water evaporator temperature [°C]
- Tamb Ambient temperature [°C DB]

**Conditions**

Cooling capacity

Capacity according to standard EN 14511 and valid for chilled water range ΔT = 3~8°C.

**Notes**

The capacity and power input is valid for -V3- models at -230-V and for -W1- models at -400-V.  
The capacity and the power input are at maximum operation.

3D146963

### 3 Capacity graphs

#### 3 - 2 Cooling Capacity Graphs - quiet mode

ERRA08-12EV3  
ERRA08-12EW1

3

Maximum cooling capacity

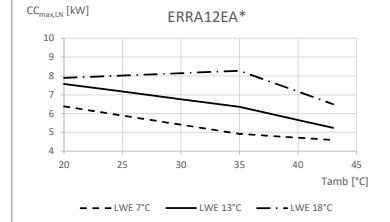
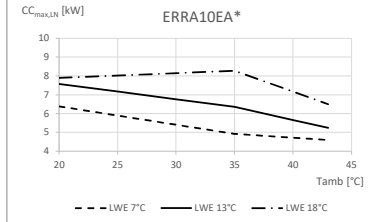
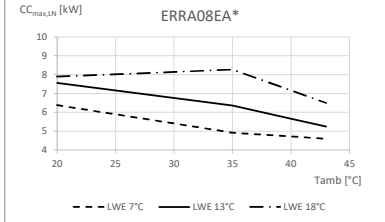

**Symbols**

CC<sub>max,LN</sub> Cooling capacity at maximum operating frequency, measured according to EN 14511.  
LWE Leaving water evaporator temperature [°C]  
Tamb Ambient temperature [°C DB]

**Conditions**

Cooling capacity

Capacity according to standard EN 14511 and valid for chilled water range ΔT = 3~8°C.

**Notes**

The capacity and power input is valid for -V3- models at -230-V and for -W1- models at -400-V.  
Full load (maximum fan rps and maximum compressor rps for the dedicated low noise mode)  
Low noise level -1-

3D146965

# 3 Capacity graphs

## 3 - 3 Heating Capacity Graphs

**ERRA08-12EV3**  
**ERRA08-12EW1**

Maximum heating capacity - integrated value

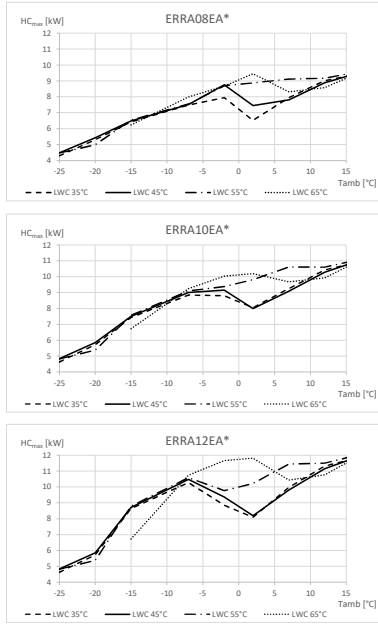

**Symbols**  
 HC<sub>max</sub> Heating capacity for maximum load, measured according to EN 14511  
 LWC Leaving water condenser temperature [°C]  
 T<sub>amb</sub> Ambient temperature [°C DB]

Maximum heating capacity - peak values

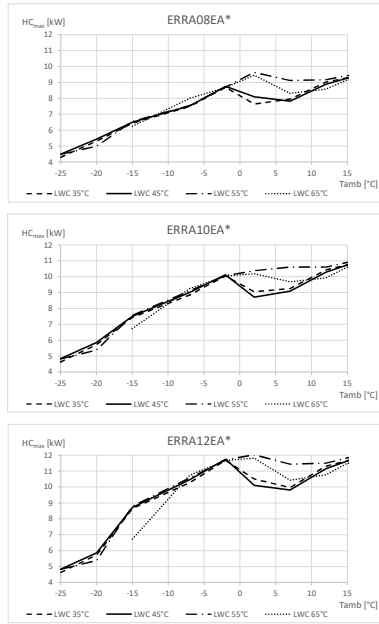

**Conditions**  
Heating capacity  
 Capacity according to standard EN 14511 and valid for heated water range  $\Delta T = 3^{\circ}\text{--}8^{\circ}\text{C}$ .  
**Notes**  
 The capacity and power input is valid for -V3- models at 230-V and for for -W1- models at 400-V.  
 The capacity and the power input are at maximum operation.

**3D146962**

### 3 Capacity graphs

#### 3 - 4 Heating Capacity Graphs - quiet mode

3

**ERRA08-12EV3**

**ERRA08-12EW1**

Maximum heating capacity - integrated value

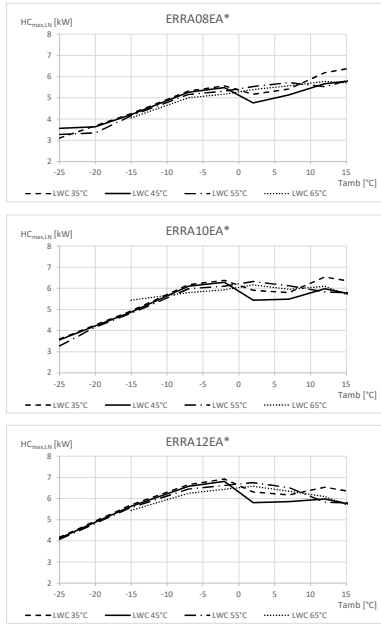

Maximum heating capacity - peak values

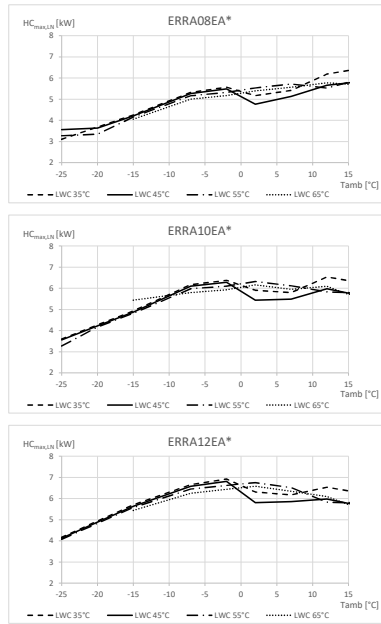

**Symbols**

HC<sub>max,LI</sub> Heating capacity for maximum load, measured according to EN 14511  
 LWC Leaving water condensator temperature [°C]  
 Tamb Ambient temperature [°C DB]

**Conditions**

Heating capacity  
 Capacity according to standard EN 14511 and valid for heated water range ΔT = 3-8°C.

**Notes**

The capacity and power input is valid for -V3- models at -230-V and for -W1- models at -400-V.  
 Full load (maximum fan rps and maximum compressor rps for the dedicated low noise mode)  
 Low noise level-1

3D146964

# 4 Capacity tables

## 4 - 1 Certification Programs

### ERRA08-12EV3 ERRA08-12EW1

Rated data for certification programmes - heating mode

Tamb [°C]	EWC	LWC	ERRA08EAV3		ERRA10EAV3		ERRA12EAV3		ERRA08EAW1		ERRA10EAW1		ERRA12EAW1		Used for:
			HC [kW]	COP	HC [kW]	COP	HC [kW]	COP	HC [kW]	COP	HC [kW]	COP	HC [kW]	COP	
7/6	30	35	6,17	4,92	6,17	4,92	6,17	4,92	6,17	5,10	6,17	5,10	6,17	5,10	Keymark, EHPA EHPA General General MCS Keymark, EHPA GET
2/1	(30)	35	5,74	4,08	5,74	4,08	5,74	4,08	5,74	4,23	5,74	4,23	5,74	4,23	
-7/-8	(30)	35	7,49	3,04	7,49	3,04	7,49	3,04	7,49	3,14	7,49	3,14	7,49	3,14	
7/6	40	45	7,73	3,57	7,73	3,57	7,73	3,57	7,73	3,70	7,73	3,70	7,73	3,70	
-2/-3	(40)	45	8,58	2,83	8,66	2,59	9,36	2,54	8,58	2,91	8,66	2,69	9,36	2,64	
7/6	47	55	7,72	2,94	7,72	2,94	7,72	2,94	7,72	3,05	7,72	3,05	7,72	3,05	
-7/-8	47	55	7,55	2,05	9,02	2,11	9,02	2,11	7,55	2,13	9,02	2,19	9,02	2,19	

Rated data for certification programmes - cooling mode

Nominal cooling capacity

Tamb [°C]	EWE	LWE	ERRA08EAV3		ERRA10EAV3		ERRA12EAV3		ERRA08EAW1		ERRA10EAW1		ERRA12EAW1		Used for:
			CC [kW]	EER	CC [kW]	EER	CC [kW]	EER	CC [kW]	EER	CC [kW]	EER	CC [kW]	EER	
35	23	18	6,47	5,56	6,47	5,56	6,47	5,56	6,47	5,75	6,47	5,75	6,47	5,75	General DAPT General
35	12	7	6,81	3,17	7,97	3,00	8,62	2,91	6,81	3,28	7,97	3,10	8,62	3,01	

Seasonal data - cooling

LWE 7°C Low temperature Application

	ERRA08EAV3	ERRA10EAV3	ERRA12EAV3	ERRA08EAW1	ERRA10EAW1	ERRA12EAW1
Pdes [kW]	6,5	7,5	8,5	6,5	7,5	8,5
SEER [-]	5,38	5,34	5,31	5,42	5,41	5,41
ηs,c [%]	212	211	209	214	214	213
QCE [kWh/annum]	725	843	961	719	831	943

Rated data for certification programmes - domestic hot water performance

Indoor unit	ELV*12S18E1*		ELV*12S23E1*		ELS(X/H)(B/-)12P30EF		ELS(X/H)(B/-)12P50EF		Used for:
	ERRA*EAV3	ERRA*EAW1	ERRA*EAV3	ERRA*EAW1	ERRA*EAV3	ERRA*EAW1	ERRA*EAV3	ERRA*EAW1	
Application	Average climate		Average climate		Average climate		Average climate		Keymark
Domestic hot water tank volume [l]	180		230		294		477		
Tapping pattern	L		L		L		XL		
Heat-up time (hh:mm:ss)	01:57:00		02:14:00		02:29:00		03:28:00		
θ <sub>wh</sub> [°C]	52,5		52,5		46,1		44,7		
P <sub>es</sub> [W]	51,7	50,7	44,8	43,9	38,1	37,4	32,7	32,5	
V <sub>40</sub> [l]	240		298		172,6		260,0		
η <sub>wh</sub> [%]	116,7	120,3	126,4	130	115,7	119,3	131,5	135,7	
COP <sub>DomW</sub> [l]	2,72	2,8	2,96	3,05	2,75	2,83	3,19	3,29	

**Symbols**

- HC Heating capacity measured according to EN 14511
- CC Cooling capacity, measured according to EN 14511.
- COP/EER Coefficient of Performance/Energy efficiency ratio according to EN 14511.
- EWC Entering water condenser temperature [°C]
- LWC Leaving water condenser temperature [°C]
- EWE Entering water evaporator temperature [°C]

- LWE Leaving water evaporator temperature [°C]
- Tamb Ambient temperature [°C DB/WB]
- θ<sub>wh</sub> Reference Domestic hot water temperature [°C]
- P<sub>es</sub> Standby power input
- V<sub>40</sub> Equivalent domestic hot water volume [l]
- η<sub>wh</sub> Efficiency [%]
- COP<sub>DomW</sub> Domestic hot water heating mode

According to EN16147.  
According to EN16147.  
According to EN16147.

Rated data for certification programmes - heating mode

Measured according to UNI/TS 11300

Condition	Tamb [°C]	LWC [°C]	PLR [%]	ERRA08EAV3		ERRA10EAV3		ERRA12EAV3		ERRA08EAW1		ERRA10EAW1		ERRA12EAW1	
				HC [kW]	COP	HC [kW]	COP	HC [kW]	COP	HC [kW]	COP	HC [kW]	COP	HC [kW]	COP
A	-7/-8	34	100	7,49	3,10	8,73	3,02	10,22	2,93	7,49	3,20	8,73	3,12	10,22	3,03
B	2/1	30	100	6,68	3,87	7,83	3,86	8,41	3,86	6,68	4,01	7,83	3,99	8,41	3,98
C	7/6	27	100	8,44	5,60	9,84	5,42	10,61	5,32	8,44	5,78	9,84	5,59	10,61	5,48
D	12/11	24	100	9,27	7,52	10,70	7,35	11,59	7,24	9,27	7,77	10,70	7,58	11,59	7,46
A	-7/-8	52	100	7,54	2,20	8,91	2,21	10,55	2,22	7,54	2,28	8,91	2,29	10,55	2,30
B	2/1	42	100	7,81	3,47	8,04	3,21	8,16	3,08	7,81	3,58	8,04	3,31	8,16	3,18
C	7/6	36	100	8,16	4,43	9,54	4,42	10,31	4,41	8,16	4,57	9,54	4,56	10,31	4,55
D	12/11	30	100	9,04	6,16	10,49	6,21	11,39	6,24	9,04	6,35	10,49	6,40	11,39	6,43

Rated data for certification programmes - cooling mode

Measured according to UNI/TS 11300

Condition	Tamb [°C]	LWE [°C]	PLR [%]	ERRA08EAV3		ERRA10EAV3		ERRA12EAV3		ERRA08EAW1		ERRA10EAW1		ERRA12EAW1	
				CC [kW]	EER	CC [kW]	EER	CC [kW]	EER	CC [kW]	EER	CC [kW]	EER	CC [kW]	EER
A	35	18	100	10,89	4,35	11,77	4,11	12,66	3,87	10,89	4,51	11,77	4,26	12,66	4,01
B	30	18	75	7,96	6,05	8,73	5,98	9,51	5,90	7,96	6,26	8,73	6,19	9,51	6,11
C	25	18	50	5,51	8,83	5,90	8,36	6,28	7,88	5,51	9,04	5,90	8,60	6,28	8,17
D	20	18	25	3,47	12,42	3,47	12,42	3,47	12,42	3,47	12,29	3,47	12,29	3,47	12,29
A	35	7	100	7,33	3,09	7,97	3,00	8,62	2,91	7,33	3,20	7,97	3,10	8,62	3,01
B	30	7	75	5,34	4,06	5,86	4,01	6,38	3,96	5,34	4,20	5,86	4,15	6,38	4,10
C	25	7	50	3,66	5,21	3,95	5,22	4,24	5,23	3,66	5,36	3,95	5,39	4,24	5,42
D	20	7	25	2,19	6,20	2,19	6,20	2,19	6,20	2,19	6,17	2,19	6,17	2,19	6,17

4D147232A

# 4 Capacity tables

## 4 - 2 Domestic Hot Water performance

4

### ERRA08-12EV3 ERRA08-12EW1

Heat-up times

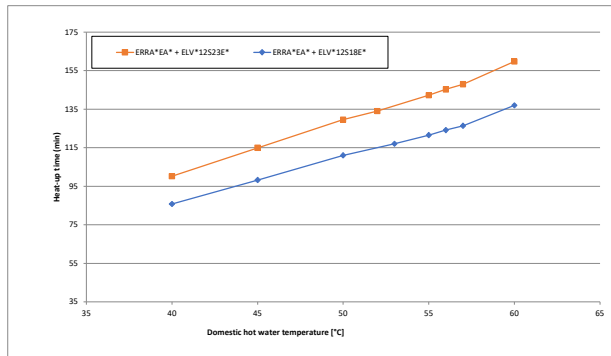

Notes

1. Time the indoor unit (heat pump only operation) requires to heat up the domestic hot water tank from 10°C to the indicated temperature. See the operation range for maximum domestic hot water tank temperature during heat pump only operation.

Model name	Heat-up time domestic hot water tank until
ERRA08/10/12/EA* + ELV*12S18E*	~98 min.
ERRA08/10/12/EA* + ELV*12S23E*	~115 min.

Selection guide for the domestic hot water tank volume

Veq 40°C = the amount of water with a temperature of 40°C that can be tapped when the domestic hot water tank is heated to a certain temperature, and the temperature of the cold inlet water is 10°C.

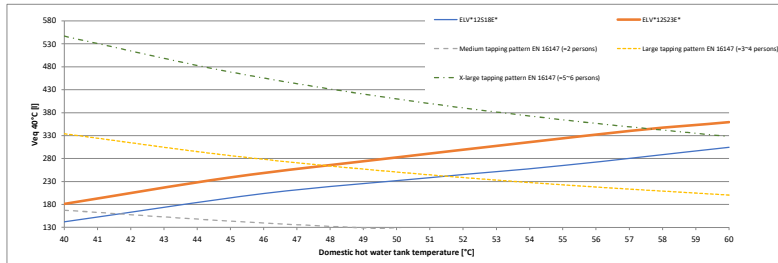

If a higher daily Veq 40°C is required, then additional heat-up cycles are required within 24 hours. See the operation manual for more information.

3D142814

### ERRA08-12EV3 ERRA08-12EW1

Heat-up times

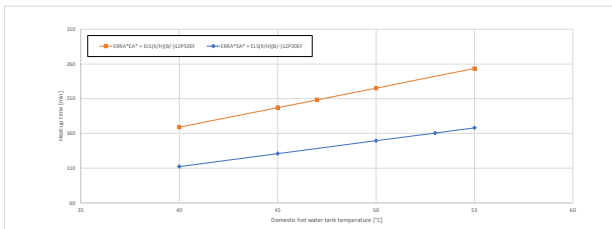

Model name	Heat-up time domestic hot water tank until 45°C
ERRA*EA* + ELS0A/HEB*12SPSEF	~124 min.
ERRA*EA* + ELS0A/HEB*12SPSEF	~137 min.

Notes

1. Time the indoor unit (heat pump only operation) requires to heat up the domestic hot water tank from 10°C to the indicated temperature. See the operation range for maximum domestic hot water tank temperature during heat pump only operation.

Selection guide for the domestic hot water tank volume

Veq 40°C = the amount of water with a temperature of 40°C that can be tapped when the domestic hot water tank is heated to a certain temperature, and the temperature of the cold inlet water is 10°C.

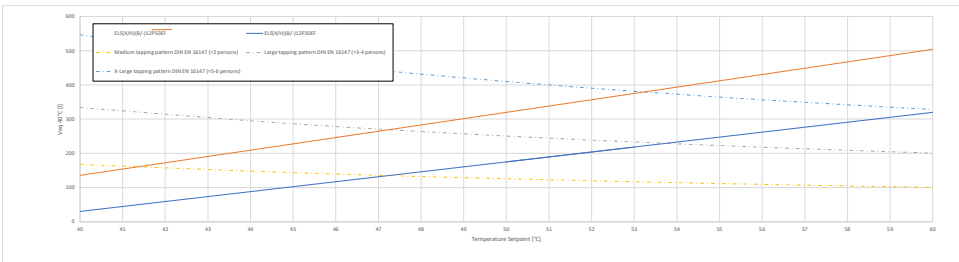

3D142814

# 5 Dimensional drawings

## 5 - 1 Dimensional Drawings

ERRA08-12EV3 / ERRA08-12EW1

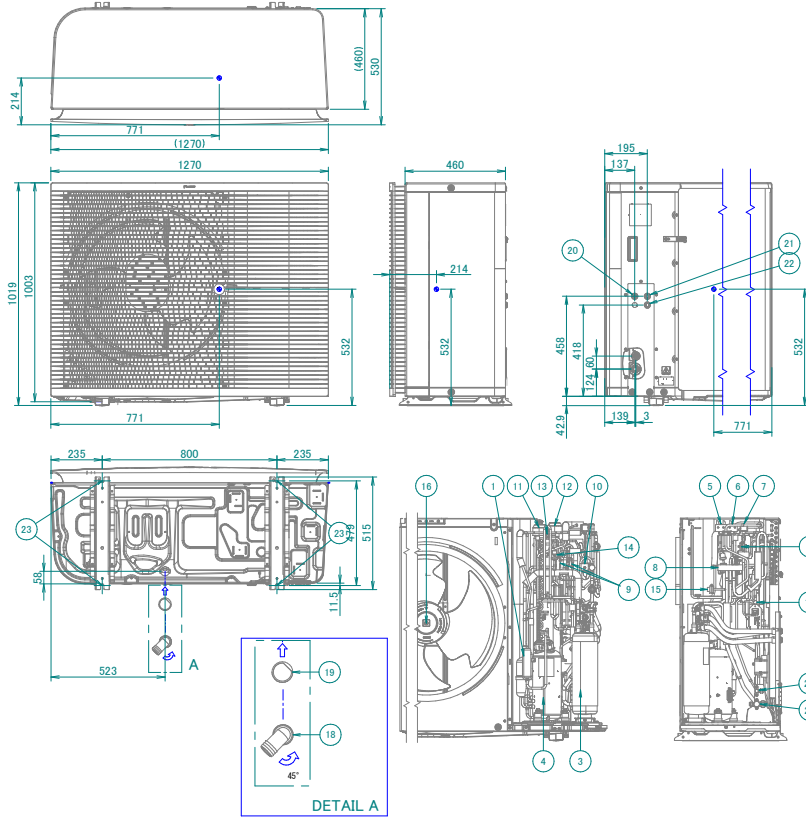

- 1 Muffler
- 2 High pressure switch ·41.7 bar·
- 3 Accumulator
- 4 Compressor
- 5 Solenoid valve (low pressure bypass)
- 6 Solenoid valve (hot gas pass)
- 7 Solenoid valve (liquid)
- 8 4-way valve
- 9 Capillary tube
- 10 4-way valve
- 11 Electronic expansion valve (main)
- 12 Electronic expansion valve (injection)
- 13 High pressure switch ·46 bar·
- 14 Low pressure switch
- 15 Pressure sensor
- 16 Fan
- 17 Service port ·5/16"· flare
- 18 Drain elbow (included accessory)
- 19 Sealing (included accessory)
- 20 Drain tube heater cable intake
- 21 Interconnection cable intake
- 22 Power supply cable intake
- 23 4 holes for anchor bolts M12
- 24 Liquid stop valve ·1/4"·
- 25 Gas stop valve ·5/8"·

3D142779

# 6 Piping diagrams

## 6 - 1 Piping Diagrams

6

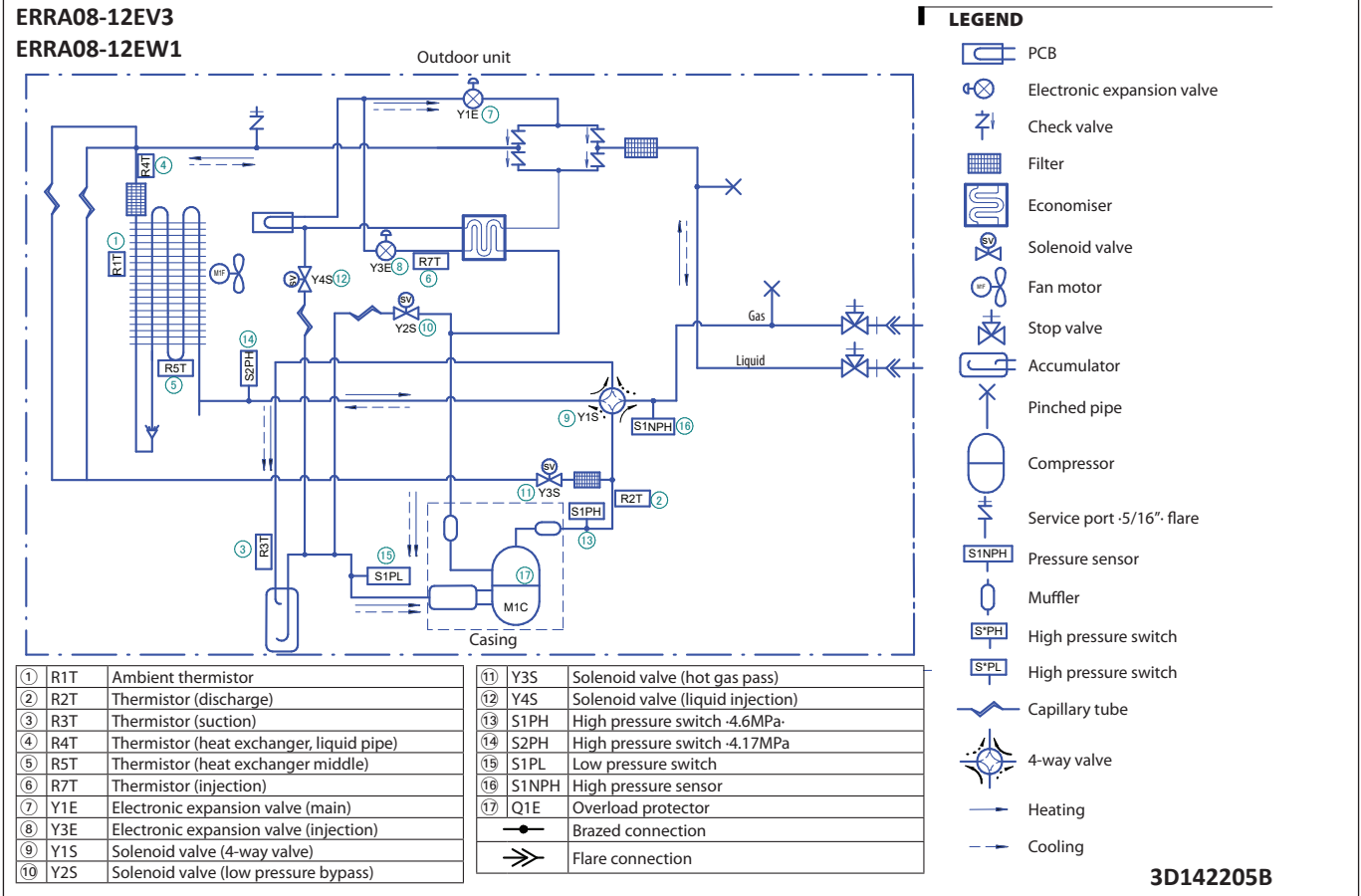

# 7 Wiring diagrams

## 7 - 1 Wiring Diagrams - Single Phase

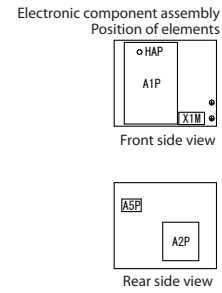
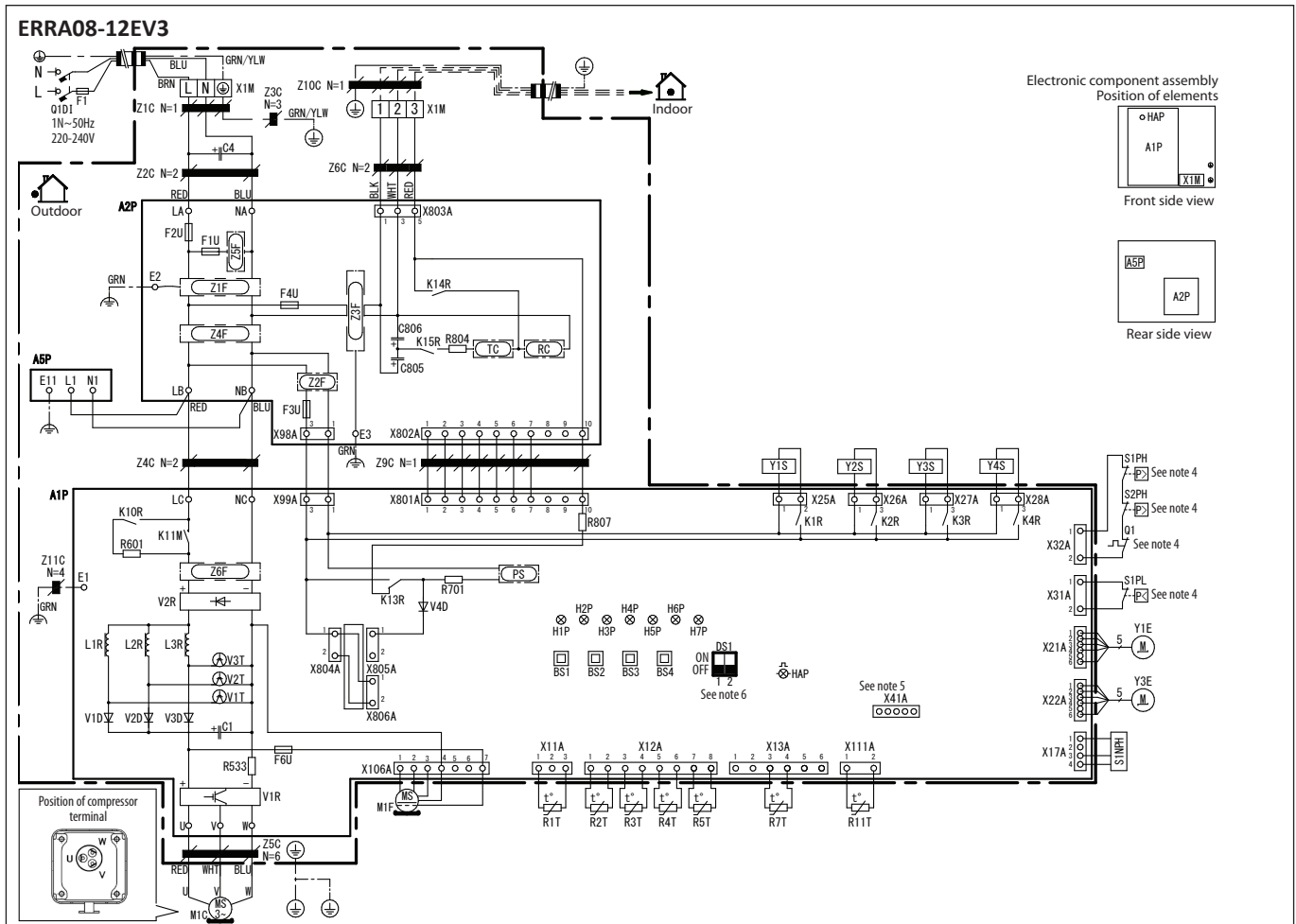

A1P	Printed circuit board (main)
A2P	Printed circuit board (noise filter)
A5P	Printed circuit board (flash)
BS1~BS4 (A1P)	Push-button switch
C1 ~ C806 (A1P, A2P)	Capacitor
DS1 (A1P)	DIP switch
F1	Field fuse (supply supply)
F1U, F3U, F4U (A2P)	Fuse (T 6.3A / 250V)
F2U (A2P)	Fuse (56 / 250V)
F6U (A1P)	Fuse (T 5.0A / 250V)
H1P~H7P (A1P)	Light-emitting diode (service monitor is orange)
HAP (A1P)	Light-emitting diode (service monitor is green)
K1R (A1P)	Magnetic relay (Y1S)
K2R (A1P)	Magnetic relay (Y2S)
K3R (A1P)	Magnetic relay (Y3S)
K4R (A1P)	Magnetic relay (Y4S)
K10R (A1P)	Magnetic relay
K11M (A1P)	Magnetic contactor
K13R~K15R (A1P, A2P)	Magnetic relay
L1R~L3R (A1P)	Reactor
M1C	Motor (compressor)
M1F	Motor (fan)
PS (A1P)	Switching power supply
Q1DI	Earth leakage circuit breaker (30mA) (field supply)
Q1	Thermal overcurrent protector
R533 ~ R807 (A1P, A2P)	Resistor
R1T	Thermistor (ambient)
R2T	Thermistor (discharge)
R3T	Thermistor (suction)
R4T	Thermistor (heat exchanger liquid pipe)
R5T	Thermistor (heat exchanger middle)
R7T	Thermistor (injection)
R11T	Thermistor (fin)
RC (A2P)	Signal receiver circuit
S1NPH	High pressure sensor
S1PH~S2PH	High pressure switch
TC (A2P)	Signal transmission circuit

V1D~V4D (A1P)	Diode
V1R (A1P)	IGBT power module
V2R (A1P)	Diode module
V1T~V3T (A1P)	Insulated Gate Bipolar Transistor (IGBT)
X1M	Terminal strip
Y1E	Electronic expansion valve (main - black)
Y3E	Electronic expansion valve (injection - blue)
Y1S	Solenoid valve (4-way valve)
Y2S	Solenoid valve (low pressure bypass)
Y3S	Solenoid valve (hot gas bypass)
Y4S	Solenoid valve (liquid injection)
Z1C~Z11C	Noise filter (ferrite core)
Z1F~Z6F (A1P, A2P)	Noise filter

**NOTES**

- L : Live
  - N : Neutral
  - ⊕ : Protective earth
  - ⊖ : Noiseless earth
  - ⏏ : Field wiring
  - ⏏ : Option
  - : Terminal strip
  - : Terminal
  - ⊞ : Connector
  - : Connection
- Colours: BLK: black, RED: red, BLU: bleu, WHT: white, GRN: green, YLW: yellow, PNK: pink, ORG: orange, GRY: grey, BRN: brown
- This wiring diagram applies only to the outdoor unit.
- When operating, do not short-circuit protection device Q1, S1PH, S2PH and S1PL.
- Refer to the combination table and the option manual for how to connect the wiring to X41A.
- The factory setting of DIP switch DS1.1 is OFF.

2D142272D

# 8 Sound data

## 8 - 1 Sound Pressure Spectrum - Cooling

8

### ERRA08-12EV3

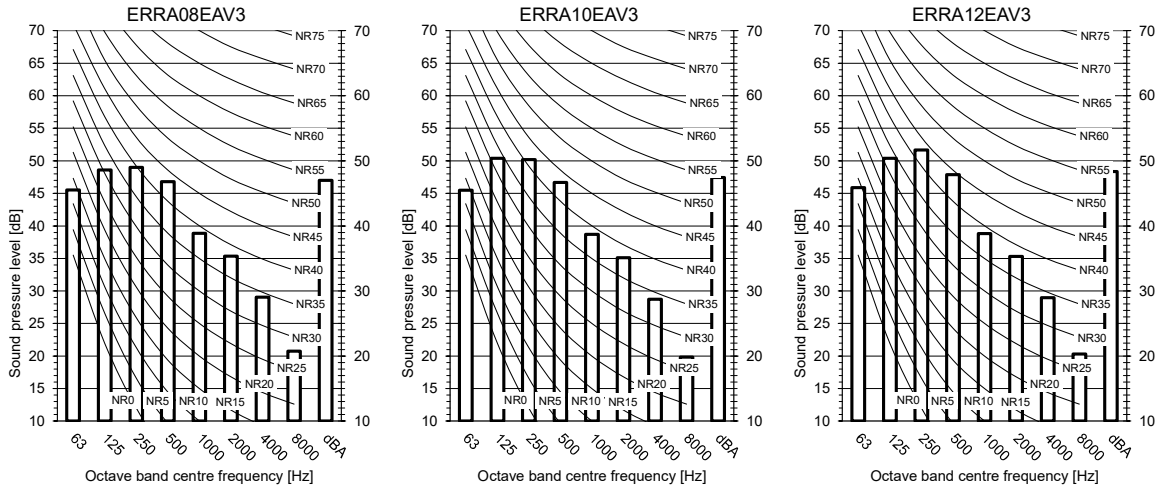

**Notes**

- Data is valid at free field condition.
- Data is valid at nominal operation condition.
- dBA = A-weighted sound pressure level (A scale according to IEC).
- Reference acoustic pressure 0 dB = 20 μPa
- If the sound is measured under actual installation conditions, the measured value will be higher due to environmental noise and sound reflections.

Measuring location  
(discharge side)

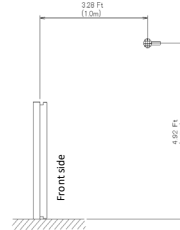

3D146968

# 8 Sound data

## 8 - 2 Sound Pressure Spectrum - Heating

ERRA08-12EV3  
ERRA08-12EW1

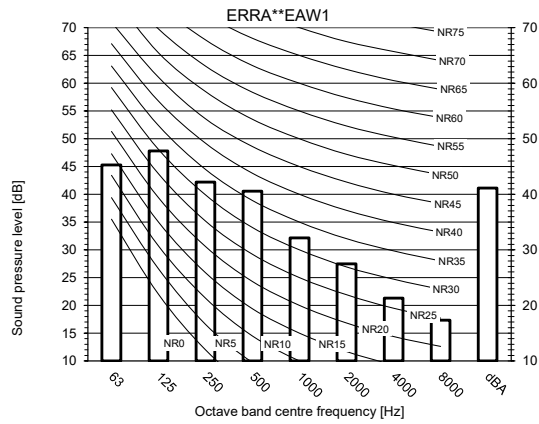
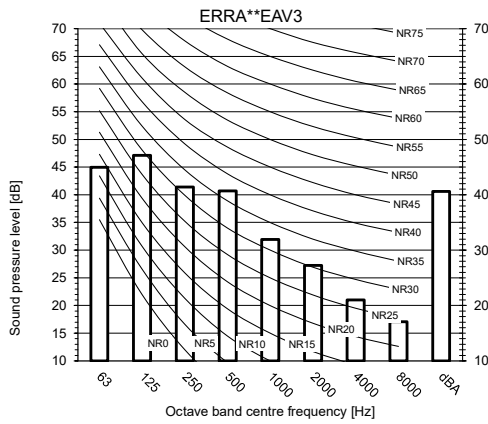

Maximum sound day	Maximum sound night	Maximum sound day Sound Power Level [dBA]			Maximum sound night Sound Power Level [dBA]		
		ERRA08EA*	ERRA10EA*	ERRA12EA*	ERRA08EA*	ERRA10EA*	ERRA12EA*
Default	Low noise level -1-	62	62	62	58,5	58,5	58,5
Low noise level -2-	Low noise level -3-	53	53	53	49,8	49,8	49,8

Full load (maximum fan rps and maximum compressor rps for the dedicated low noise mode)

Measuring location  
(discharge side)

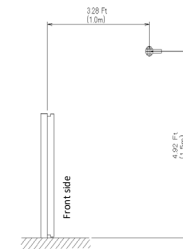

**Notes**

- Data is valid at free field condition.
- Data is valid at nominal operation condition.
- Conditions: Ta DB/WB -7/-6°C - LWC -35°C
- dBA = A-weighted sound pressure level (A scale according to IEC).
- Reference acoustic pressure 0 dB = 20 µPa
- \* If the sound is measured under actual installation conditions, the measured value will be higher due to environmental noise and sound reflections.

3D146966

# 8 Sound data

## 8 - 3 Sound Pressure Spectrum Quiet Mode

8

ERRA08-12EV3  
ERRA08-12EW1

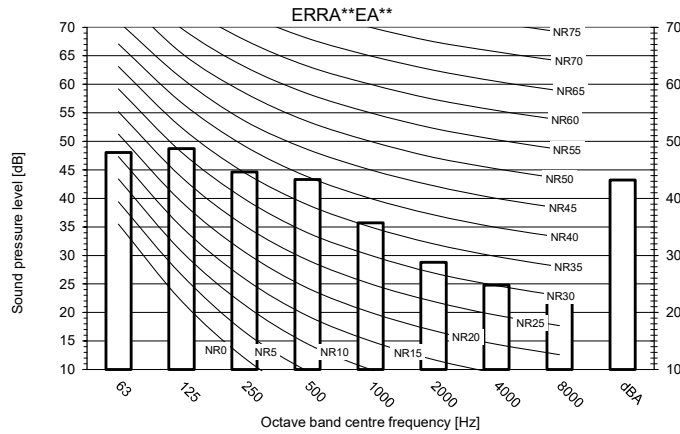

Maximum sound day	Maximum sound night	Maximum sound day			Maximum sound night		
		Sound Power Level [dBA]			Sound Power Level [dBA]		
Default	Low noise level ·1·	ERRA08EA*	ERRA10EA*	ERRA12EA*	ERRA08EA*	ERRA10EA*	ERRA12EA*
		62	62	62	58,5	58,5	58,5
Low noise level ·2·	Low noise level ·3·	53	53	53	49,8	49,8	49,8

Full load (maximum fan rps and maximum compressor rps for the dedicated low noise mode)

**Notes**

- Data is valid at free field condition.
- Data is valid at nominal operation condition.
- Conditions: Ta DB/WB -7/-6°C - LWC -55°C
- dBA = A-weighted sound pressure level (A scale according to IEC).
- Reference acoustic pressure 0 dB = 20 µPa
- If the sound is measured under actual installation conditions, the measured value will be higher due to environmental noise and sound reflections.

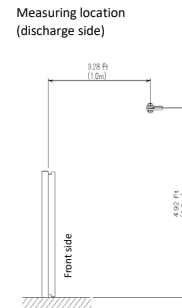

3D146967

ERRA08-12EV3  
ERRA08-12EW1

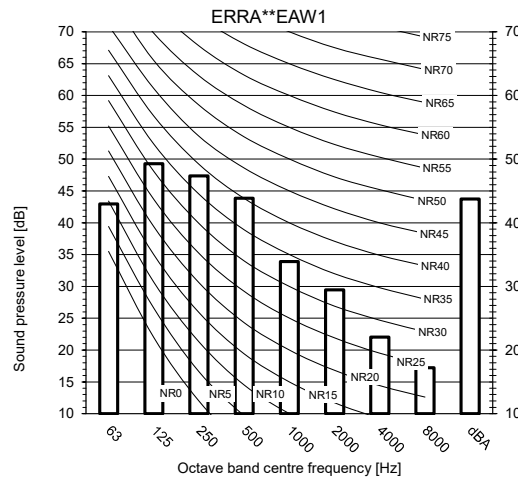
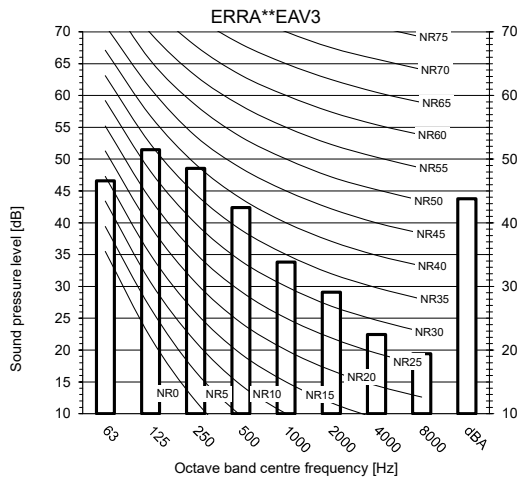

**Notes**

- Data is valid at free field condition.
- Data is valid at nominal operation condition.
- dBA = A-weighted sound pressure level (A scale according to IEC).
- Reference acoustic pressure 0 dB = 20 µPa
- If the sound is measured under actual installation conditions, the measured value will be higher due to environmental noise and sound reflections.

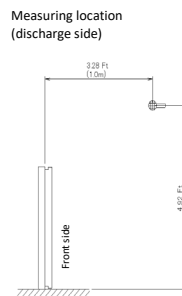

3D146969

# 9 Installation

## 9 - 1 Installation Method

ERRA08-12EV3  
ERRA08-12EW1

Minimum space for air passage

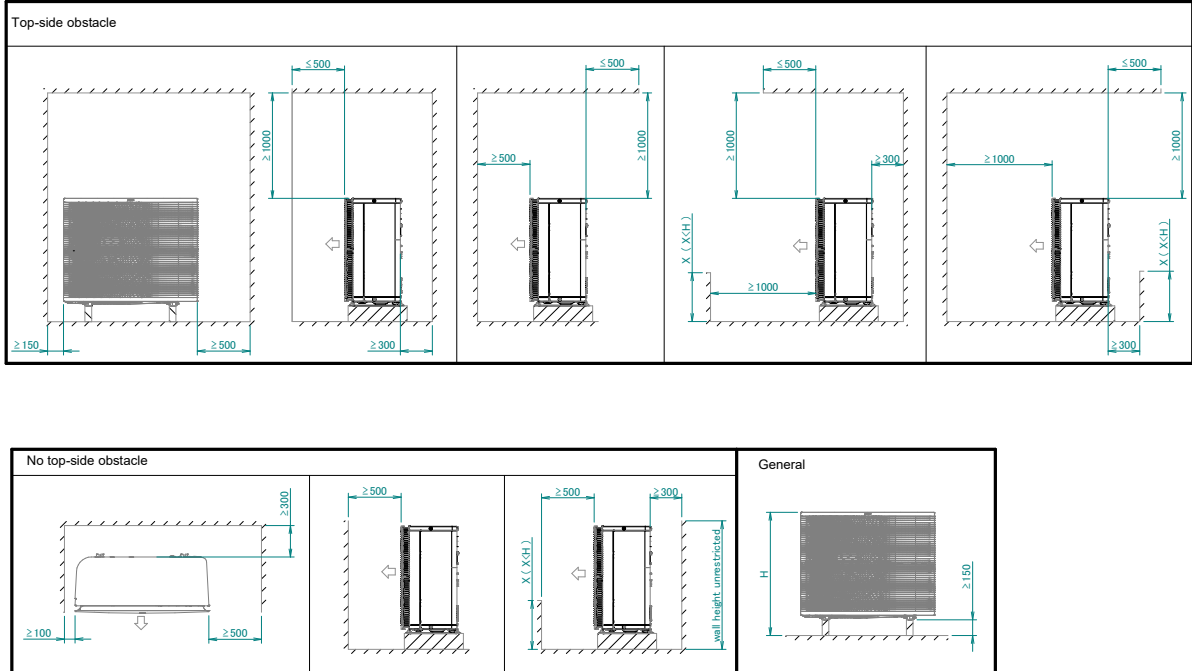

3D145275

# 10 Operation range

## 10 - 1 Operation Range

10

ERRA08-12EV3  
ERRA08-12EW1

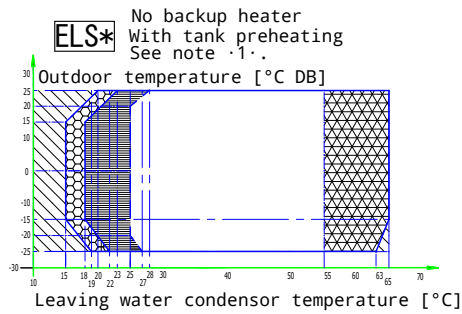
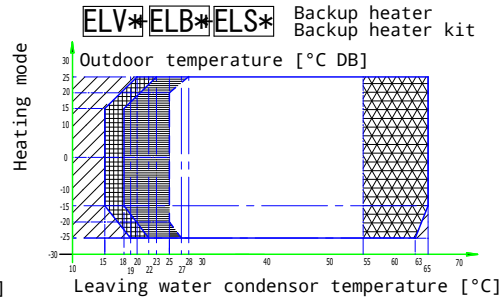
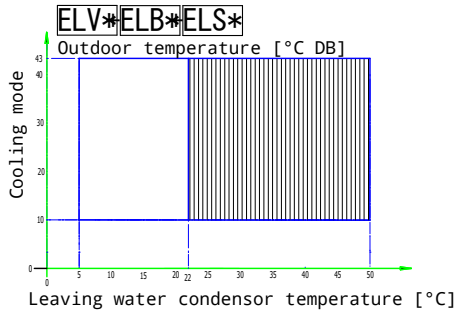

**Legend**

- Backup heater only operation
- No outdoor unit operation
- Heat pump + backup heater operation
- Pull-up area
- Auxiliary boiler only operation
- No outdoor unit operation
- Heat pump + auxiliary boiler operation
- Pull-up area
- Outdoor unit operation if controller setpoint is regulated to minimal leaving water temperature request.

See dashed lines

Outdoor unit operation if setpoint > 55°C and ΔT = 10°C (ΔT = outlet temperature - inlet temperature)

Pull-down area

**Notes**

1. Tank preheating  
For details, see the installer reference guide.
2. In restricted power supply mode, the outdoor unit and backup heater can only operate separately.

3D142809

ERRA08-12EV3  
ERRA08-12EW1

**Domestic hot water heating mode**

ELV\* + ELS\* + EKHWP\* +  
EKHWS\*200\*  
EKHWS\*250\*  
EKHWS\*300\*

+  
Third-party with identical specifications as EKHWS\*200\*

EKHWS\*150\*  
EKHWS\*180\*

+  
Third-party with identical specifications as EKHWS\*150\*

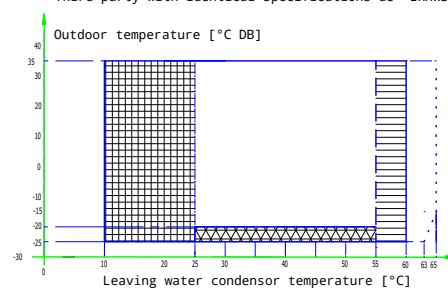
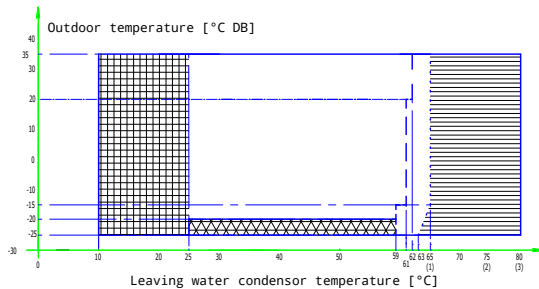

**Legend**

- Setpoint [°C]
- Domestic hot water
- Leaving water temperature [°C]
- Pull-up area
- Booster heater only operation (if a booster heater is part of the system)
  - (1) ELV\*12\* indoor units only
  - (2) Combination of EKHWS\* and ELB\* indoor units / ELS\*12\* indoor units only
  - (3) Combination of EKHWP\* and ELB\* indoor units
- Operation of the outdoor unit is possible. If the outdoor temperature drops below -20°C, unit will continue operation. But when the unit is OFF and the outdoor temperature is below -20°C, the outdoor unit will not start up. The indoor unit and backup heater will start in these cases.

**Notes**

1. In restricted power supply mode (EKHW\* only), the outdoor unit, booster heater and backup heater can only operate separately.
2. Third-party with identical specifications as EKHWS\*150\*  
Coil surface > 1.05·m<sup>2</sup> and < 3.7·m<sup>2</sup>  
Tank thermistor and booster heater above heat pump coil.
3. Third-party with identical specifications as EKHWS\*200\*  
Coil surface > 1.8·m<sup>2</sup> and < 3.7·m<sup>2</sup>  
Tank thermistor and booster heater above heat pump coil.

3D142810

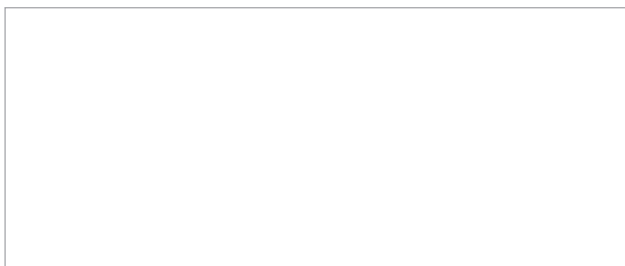

EEDEN23A

08/2023



The present leaflet is drawn up by way of information only and does not constitute an offer binding upon Daikin Europe N.V. Daikin Europe N.V. has compiled the content of this leaflet to the best of its knowledge. No express or implied warranty is given for the completeness, accuracy, reliability or fitness for particular purpose of its content and the products and services presented therein. Specifications are subject to change without prior notice. Daikin Europe N.V. explicitly rejects any liability for any direct or indirect damage, in the broadest sense, arising from or related to the use and/or interpretation of this leaflet. All content is copyrighted by Daikin Europe N.V.